

University of Alberta

A Conceptual Approach to Subterranean Oil Sand Fragmentation and
Slurry Transport

by

S.C. Anthony Lam

A thesis submitted to the Faculty of Graduate Studies and Research
in partial fulfillment of the requirements for the degree of

Master of Science

Department of Mechanical Engineering

© S.C. Anthony Lam
Fall 2010
Edmonton, Alberta

Permission is hereby granted to the University of Alberta Libraries to reproduce single copies of this thesis and to lend or sell such copies for private, scholarly or scientific research purposes only. Where the thesis is converted to, or otherwise made available in digital form, the University of Alberta will advise potential users of the thesis of these terms.

The author reserves all other publication and other rights in association with the copyright in the thesis and, except as herein before provided, neither the thesis nor any substantial portion thereof may be printed or otherwise reproduced in any material form whatsoever without the author's prior written permission.



Library and Archives
Canada

Published Heritage
Branch

395 Wellington Street
Ottawa ON K1A 0N4
Canada

Bibliothèque et
Archives Canada

Direction du
Patrimoine de l'édition

395, rue Wellington
Ottawa ON K1A 0N4
Canada

Your file Votre référence
ISBN: 978-0-494-68011-7
Our file Notre référence
ISBN: 978-0-494-68011-7

NOTICE:

The author has granted a non-exclusive license allowing Library and Archives Canada to reproduce, publish, archive, preserve, conserve, communicate to the public by telecommunication or on the Internet, loan, distribute and sell theses worldwide, for commercial or non-commercial purposes, in microform, paper, electronic and/or any other formats.

The author retains copyright ownership and moral rights in this thesis. Neither the thesis nor substantial extracts from it may be printed or otherwise reproduced without the author's permission.

AVIS:

L'auteur a accordé une licence non exclusive permettant à la Bibliothèque et Archives Canada de reproduire, publier, archiver, sauvegarder, conserver, transmettre au public par télécommunication ou par l'Internet, prêter, distribuer et vendre des thèses partout dans le monde, à des fins commerciales ou autres, sur support microforme, papier, électronique et/ou autres formats.

L'auteur conserve la propriété du droit d'auteur et des droits moraux qui protègent cette thèse. Ni la thèse ni des extraits substantiels de celle-ci ne doivent être imprimés ou autrement reproduits sans son autorisation.

In compliance with the Canadian Privacy Act some supporting forms may have been removed from this thesis.

While these forms may be included in the document page count, their removal does not represent any loss of content from the thesis.

Conformément à la loi canadienne sur la protection de la vie privée, quelques formulaires secondaires ont été enlevés de cette thèse.

Bien que ces formulaires aient inclus dans la pagination, il n'y aura aucun contenu manquant.

Canada

Examining Committee

Michael Lipsett, Mechanical Engineering

David Nobes, Mechanical Engineering

Amit Kumar, Mechanical Engineering

Tim Joseph, Mining Engineering

Abstract

Oil sand deposits are found at three depths; shallow, intermediate, and deep. Shallow deposits are processed by surface mining while deep deposits are processed using thermal extraction methods. There are currently no production methods to extract oil sand at intermediate depths. The motivation for this research is to demonstrate the technical applicability of methods to access oil sand that is too shallow for thermal extraction methods and too deep for economical surface mining.

This work consisted of developing a system concept as a method for accessing, fragmenting, and removing oil sand at intermediate depths. A technical analysis and a cost estimate were also performed. In addition, the applicability of a comparative methodology was demonstrated with case studies.

A key gap in the understanding of how to implement the system concept is tooling design and power requirements for fragmenting oil sand and interburden; and so a set of laboratory experiments was conducted to investigate the power required to cut oil sand. Oil sand blocks were formed from oil sand samples for the experiments. These blocks underwent various tests to examine their characteristics. Tests included: shear testing, extraction testing, porosity measurements, and scanning electron microscopy.

Lab-scale experiments were conducted in dry, wet, and frozen conditions in support of the fragmentation aspect of the system concept. Thermal imaging was used to qualitatively view temperature variation during the testing process and cutter wear was viewed using a digital microscope. Results were compared against a steady-state cutting model with recommendations for future work.

Table of Contents

Chapter 1 Introduction	1
1.1 Overview of Alberta’s Oil Sands	1
1.2 Oil Sand Projects	2
1.3 Challenges	7
1.4 Layout of Thesis	7
Chapter 2 Literature Review	9
2.1 Introduction	9
2.2 Drilling Mechanisms	9
2.2.1 Mechanical Drilling Methods	9
2.2.2 Thermal Energy Drilling Methods	16
2.2.3 Liquefaction Drilling Methods	19
2.2.4 Chemical Energy Drilling Methods	20
2.2.5 Sonic Energy Drilling Methods	21
2.2.6 Hydraulic Forces	21
2.2.7 Electrical Energy Drilling Method	22
2.2.8 Light Energy Drilling Methods	23
2.2.9 Applicability of Drilling Methods for Oil Sands Underground Production ..	23
2.3 Horizontal and Directional Drilling	25
2.3.1 Introduction	25
2.3.2 Stages	25
2.3.3 Applications	26
2.3.4 Costs	26
2.3.5 Benefits	27
2.3.6 Future Developments	28
2.3.7 Horizontal Drilling for Thermal In-Situ Production Methods	29

2.3.8	Cyclic Steam Stimulation	32
2.3.9	Application of Horizontal and Directional Drilling for Oil Sands Underground Production.	34
2.4	Fracing.....	34
2.4.1	Introduction.....	34
2.4.2	Applicability	35
2.4.3	Procedure	35
2.4.4	Costs.....	36
2.4.5	Geotechnical Considerations	36
2.4.6	Applicability of Fracing to Oil Sands Underground Production	37
2.5	Cold Heavy Oil Production with Sand.....	38
2.5.1	Introduction.....	38
2.5.2	Applicability	38
2.5.3	Benefits	39
2.5.4	Limitations	40
2.5.5	Costs.....	40
2.5.6	Applicability of CHOPS to Oil Sands Underground Production.....	41
2.6	Mining.....	41
2.6.1	Introduction.....	41
2.6.2	Surface Mining vs. Underground Mining.....	42
2.6.3	Underground Mining	44
2.6.4	Mechanical Extraction	44
2.6.5	Aqueous Extraction Mining Methods.....	47
2.6.6	Unsupported Mining Methods	51
2.6.7	Supported Mining Methods	52
2.6.8	Caving Methods.....	53
2.6.9	Summary of Mining Options for Oil Sands Underground Production.....	54
2.7	Summary of Current Technology Options.....	54
Chapter 3	System Concept.....	56
3.1	Introduction.....	56
3.2	Concept Development.....	56

3.3	Description.....	58
3.3.1	Process Flow Diagram.....	58
3.3.2	Graphical Representation.....	60
3.3.3	Operating Stages.....	63
3.4	Technical and Economic Assessment.....	65
3.4.1	Introduction.....	65
3.4.2	General Assumptions.....	65
3.4.3	Recovery.....	65
3.4.4	Estimated Bitumen Production.....	66
3.4.5	Common Capital.....	67
3.4.6	Per Well Capital.....	69
3.4.7	Capital Expenditures.....	72
3.4.8	Operating Expense.....	72
3.4.9	Summary.....	74
3.5	Other Technical Considerations.....	75
3.5.1	Wear Damage.....	75
3.5.2	Infrastructure.....	76
3.5.3	Winter Operability.....	76
3.5.4	Water Requirements.....	76
3.5.5	Pumping Requirements.....	77
3.5.6	Cavity Integrity.....	77
3.6	Technology Development Requirements.....	78
3.7	Testing.....	79
Chapter 4	Experimental Setup.....	80
4.1	Introduction.....	80
4.2	Equipment.....	80
4.2.1	The Oil Sand Cutting Test Instrument.....	80
4.2.2	Torque Instrumentaion.....	82
4.2.3	Measurement of Horizontal Force.....	85
4.2.4	Data Acquisition.....	87

4.3	Oil Sand Introduction.....	88
4.4	Oil Sand Sampling Limitations and Techniques	89
4.4.1	Engineered Oil Sand	90
4.4.2	Ottawa Silica Sand	90
4.4.3	Tailings Sand	91
4.4.4	Silica Sand	91
4.4.5	Plasticine	91
4.4.6	Oil Sand Blocks	92
4.5	Custom-Made Oil Sand Blocks	92
4.5.1	Consolidation	92
4.5.2	Freezing.....	93
4.5.3	Storage	94
4.5.4	Conclusion	95
4.6	Experimental Design.....	95
4.6.1	Introduction.....	95
4.6.2	Key Variables.....	96
4.6.3	Measured Variables	98
4.6.4	Controlled Variables	98
4.6.5	Chip Load.....	98
4.7	Summary	101
Chapter 5 Results and Discussion.....		102
5.1	Introduction.....	102
5.2	Shear Testing	102
5.3	Dean-Stark Extraction Test.....	104
5.4	Porosity Measurements.....	105
5.5	Scanning Electron Microscopy	105
5.6	Thermal Imaging.....	109
5.7	Digital Microscopy of Tool Tip.....	111
5.8	Fragmentation Tests.....	114
5.8.1	Test Plan.....	114

5.8.2	Data Processing.....	115
5.8.3	Sampling Rate.....	116
5.8.4	Dry Oil Sand Fragmentation Tests	117
5.8.5	Wet Oil Sand Fragmentation Tests.....	121
5.8.6	Frozen Oil Sand Fragmentation Tests.....	125
5.8.7	Dry Oil Sand vs. Wet Oil Sand.....	129
5.8.8	Thawed Oil Sand vs. Frozen Oil Sand.....	133
5.9	Analytical Modeling	136
5.10	Energy Consumption	140
5.11	Machinability Factor.....	142
5.12	Sources of Error	143
5.12.1	Equipment Influences	143
5.12.2	The Milling Process	145
5.12.3	Sample Influences.....	145
5.12.4	Human Influences	145
5.13	Summary of Findings.....	146
5.14	Industrial Scale-up	147
Chapter 6 Conclusions.....		149
6.1	Summary.....	149
6.2	Conclusions.....	150
6.3	Recommendations for Future Work.....	151
References.....		154
Appendices.....		161
A	Oil Sand Lump Extraction Procedure.....	161
B	Energy Consumption Estimation	163

List of Tables

Table 2-1 Auger comparison	16
Table 2-2 Drilling technologies and their applicability for oil sand recovery	24
Table 2-3 Fracing suitability	37
Table 3-1 Water supply components	68
Table 3-2 Casing specifications	70
Table 4-1 Chip load	99
Table 5-1 Shear testing parameters	103
Table 5-2 Extraction testing result	104
Table 5-3 Test matrix	114
Table 5-4 Parameters adjusted for cutting conditions	138
Table 5-7 Summary of findings for controlled parameters	146
Table 5-8 Summary of findings for multiple cutting conditions	147
Table 6-1 Power consumptions for various equipment	163
Table 6-2 Ambient temperature and its effect on a loaded conveyor's power consumption ..	164
Table 6-3 Approximate power consumption for surface mining equipment in oil sand	165

List of Figures

Figure 1-1	Limitations of current solutions	2
Figure 2-1	Classification of mining methods under investigation.....	42
Figure 2-2	Oil sands surface mining extraction and processing stages	46
Figure 2-3	Borehole mining schematic.....	47
Figure 2-4	Dredging examples.....	51
Figure 2-5	Longwall mining machine.....	53
Figure 3-1	System concept development stages	57
Figure 3-2	Process flow diagram	59
Figure 3-3	Vertical configuration	60
Figure 3-4	Vertical configuration with tooling deployed	60
Figure 3-5	Horizontal configuration	61
Figure 3-6	Horizontal configuration with tooling deployed.....	61
Figure 3-7	Graphical representation	62
Figure 3-8	CAD model of the cutting tool in its closed position.....	62
Figure 3-9	CAD model of the cutting tool in its operating position.....	63
Figure 4-1	Instrumented mill	81
Figure 4-2	Photograph of the instrumented mill.....	82
Figure 4-3	Strain gauge configuration	83
Figure 4-4	Torque measuring apparatus	84
Figure 4-5	Torque cell calibration data.....	85
Figure 4-6	Horizontal cutting force measurement setup.....	86
Figure 4-7	Load cell calibration data	87
Figure 4-8	Data flow diagram.....	88

Figure 4-9 Photograph of oil sand block making work area.....	93
Figure 4-10 A frozen oil sand block	94
Figure 4-11 Oil sand blocks stored in air-tight packing in a cold environment ..	95
Figure 4-12 Feed rate relationship	97
Figure 4-13 Chip load vs feed rate.....	100
Figure 4-14 Chip load vs rotational speed	100
Figure 5-1 Direct shear strength	104
Figure 5-2 SEM image of oil sand at 45x magnification.....	106
Figure 5-3 SEM image of oil sand at 50x magnification.....	107
Figure 5-4 SEM image of oil sand at 500x magnification.....	107
Figure 5-5 SEM image of oil sand at 1000x magnification.....	108
Figure 5-6 SEM image of oil sand at 2000x magnification.....	108
Figure 5-7 An oil sand block resting on a surface	109
Figure 5-8 Thermal distribution during the fragmenting process	110
Figure 5-9 Thermal distribution during the fragmenting process	110
Figure 5-10 Thermal distribution during the fragmenting process	110
Figure 5-11 Thermal distribution during the fragmenting process	110
Figure 5-12 Thermal distribution during the fragmenting process	110
Figure 5-13 Cutting corner of a new removable insert at 10x magnification....	111
Figure 5-14 Cutting corner of a new removable insert at 63x magnification....	111
Figure 5-15 Cutting edge of a new removable insert at 10x magnification.....	112
Figure 5-16 Cutting edge of a new removable insert at 63x magnification.....	112
Figure 5-17 Cutting corner of a used removable insert at 10x magnification ...	112
Figure 5-18 Cutting corner of a used removable insert at 63x magnification ...	112
Figure 5-19 Cutting edge of a used removable insert at 10x magnification.....	113
Figure 5-20 Cutting edge of a used removable insert at 63x magnification.....	113
Figure 5-21 A data set of the cutting process	115
Figure 5-22 Force as a function of rotational speed for dry oil sand.....	117
Figure 5-23 Torque as a function of rotational speed for dry oil sand	118
Figure 5-24 Force as a function of feed rate for dry oil sand	119

Figure 5-25 Torque as a function of feed rate for dry oil sand	120
Figure 5-26 Force as a function of rotational speed for wet oil sand	121
Figure 5-27 Torque as a function of rotational speed for wet oil sand	122
Figure 5-28 Force as a function of feed rate for wet oil sand	123
Figure 5-29 Torque as a function of feed rate for wet oil sand.....	124
Figure 5-30 Force as a function of rotational speed for frozen oil sand	125
Figure 5-31 Torque as a function of rotational speed for frozen oil sand.....	126
Figure 5-32 Force as a function of feed rate for frozen oil sand.....	127
Figure 5-33 Torque as a function of feed rate for frozen oil sand	128
Figure 5-34 Force as a function of feed rate in dry and wet conditions	129
Figure 5-35 Torque as a function of feed rate in dry and wet conditions	130
Figure 5-36 Force as a function of rotational speed in dry and wet conditions.	131
Figure 5-37 Torque as a function of rotational speed in dry and wet conditions	132
Figure 5-38 Force as a function of feed rate in frozen and thawed conditions..	133
Figure 5-39 Torque as a function of feed rate in frozen and thawed conditions	134
Figure 5-40 Force as a function of rotational speed in frozen and thawed conditions	135
Figure 5-41 Torque as a function of rotational speed in frozen and thawed conditions	136
Figure 5-42 Empirical vs analytical results for force under dry and wet cutting conditions .	138
Figure 5-43 Empirical vs analytical results for force under thawed and frozen cutting conditions....	139
Figure 5-48 Energy consumption for dry and wet cutting conditions	140
Figure 5-49 Energy consumption for frozen and thawed cutting conditions.....	141
Figure 5-50 Feed rate trend.....	144

List of Nomenclature

Acronyms

AASHTO	American Association of State Highway and Transportation Officials
AOSP	Athabasca Oil Sands Project
ASTM	American Society for Testing and Materials
bb/d	barrels per day
BCM	bank cubic meter
BHM	borehole mining
BP	British Petroleum
CAPEX	capital expenditures
CHOPS	cold heavy oil production with sand
CNRL	Canadian Natural Resources
cP	centipose
CSS	cyclic steam stimulation
D	Darcy
DOE	design of experiment
EOR	enhanced oil recovery
ha	hectare
IOR	Imperial Oil Resources
IRR	internal rate of return
LASER	light amplification by stimulated emission of radiation
	liquid assisted steam enhanced recovery
Mcf/bbl	thousand cubic feet per barrel
md	millidarcy

MD	measured depth
MWD	measurement while drilling
NMR	nuclear magnetic resonance
OD	outer diameter
OOIP	original oil in place
OPEX	operating expense
PCP	progressing cavity pump
PDM	positive displacement motors
SAGD	steam assisted gravity drainage
SEM	scanning electron microscopy
TBM	tunnel boring machine
THAI	toe to heel air injection
WOB	weight on bit
XRD	x-ray diffraction
XRF	x-ray fluorescence

Notation

a	cross-section area of nozzle
c	cohesion
d	tool depth
F	horizontal force
f	feed rate
g	gravitational constant
L	chip load
l	tool length
N	number of teeth
n	number of nozzles
p	fluid pressure
R	rotational speed

v	tool speed
w	fluid density
	tool width

Greek Symbols

β	rake angle
γ	specific weight
δ	external friction angle
ρ	shear plane angle
ϕ	internal friction angle

Chapter 1 Introduction

1.1 Overview of Alberta's Oil Sands

The province of Alberta contains the world's largest oil sand deposit equivalent to approximately 1.7 trillion barrels of bitumen (Heidrick, 2006 and Alberta Energy, 2009). This amount ranks Alberta second in the world in proven oil reserves behind Saudi Arabia's 2.6 trillion barrels of bitumen (Alberta Energy, 2009).

With geopolitical instability in some regions of the world and risks associated with other forms of oil production such as offshore drilling, Alberta's oil sands are a valuable and strategic source of crude oil. These oil sand deposits cover 140,200 km² of the province and are found in three regions; Athabasca (Fort McMurray area), Peace River, and Cold Lake (Alberta Department of Energy, 2007). Within these regions, these oil sand deposits are found at three depths: shallow, intermediate, and deep. Shallow deposits are defined as those which are economically processed by surface mining. Deep deposits are currently processed using thermal extraction techniques, on the order of 600 metres, depending on the depositional environment. There is, however, no production method for oil sands at intermediate depths, which are too deep for surface mining and too shallow for in-situ methods (Lipsett et al., 2007). The motivation for this research is to demonstrate the technical applicability of methods to produce bitumen oil sand slurry from deposits at intermediate depths. The following figure depicts the amount of bitumen under investigation.

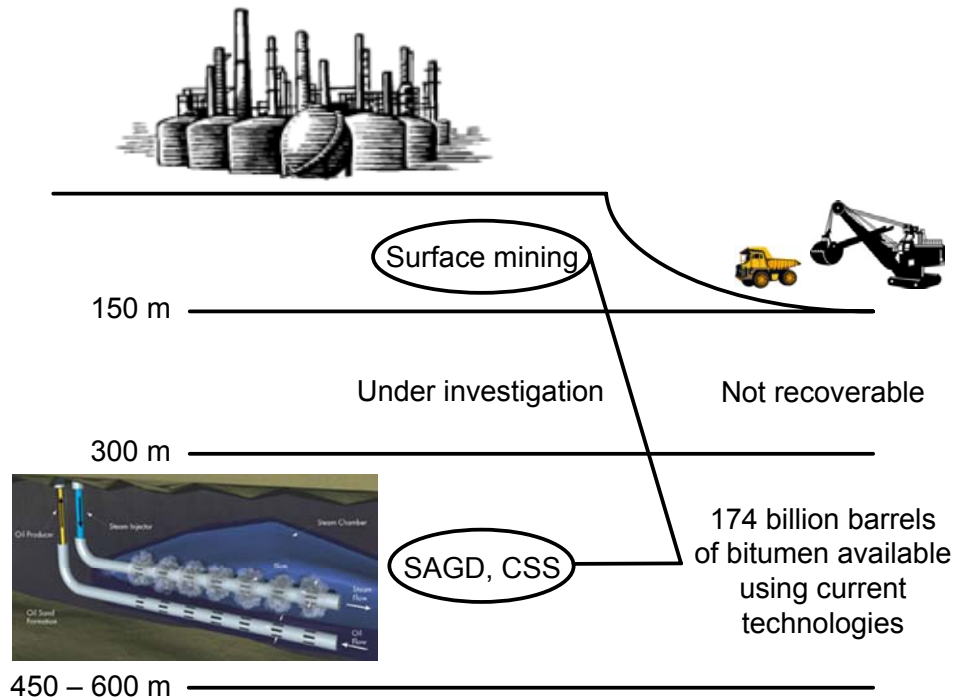

Figure 1-1 Limitations of current solutions

1.2 Oil Sand Projects

This section provides an overview of some current and planned oil sands projects in Alberta. These projects use the truck and shovel mining method and/or current commercial in-situ recovery techniques. It should be noted that the information was obtained from publically available sources and is known to be current as of the second quarter of 2008. Also, this list is not meant to be a complete listing but rather a brief synopsis because access to information is extremely difficult to obtain. Lastly, projects of these magnitudes will ultimately be affected due to economic and political influences.

Imperial Oil

Imperial Oil Resources fully owns and operates a thermal in-situ oil recovery operation in Cold Lake. Commercial production commenced in 1985 employing cyclic steam stimulation (CSS). In 2008, it was reported that there was over

4,000 wells at their site producing approximately 150,000 bbl/d of oil. In addition, a new EOR method is being commercialized in Cold Lake known as LASER (liquid addition to steam for enhanced recovery). LASER was designed to act as a technology enhancement to CSS where a low concentration of diluent is added to the steam resulting in a further reduction in viscosity thereby increasing production. LASER has been applied to 200 wells (Fair et al., 2008).

Kearl is another Imperial Oil project. The Kearl Oil Sands Project is jointly owned by Imperial Oil (70 %) and ExxonMobil (30 %). Kearl is located 70 km northeast of Fort McMurray and will be a surface mining operation. Development will be conducted in phases with an initial target of 100,000 bbl/d of bitumen by 2012. With later expansions, eventual production is anticipated to increase to 345,000 bbl/d of bitumen (Imperial Oil Limited, 2010).

Athabasca Oil Sands Project

The Athabasca Oil Sands Project (AOSP) is a joint venture between Marathon Oil (20 %), Chevron (20 %), and Shell (60 %). This project consists of the Muskeg River Mine located 75 km north of Fort McMurray and the Scotford upgrader situated in Fort Saskatchewan. Currently, the production capacity of the Muskeg River Mine is 155,000 bbl/d. In 2010, production capacity will be increased by adding another 100,000 bbl/d (Robertson, 2008).

ConocoPhillips

ConocoPhillips created partnerships with various energy companies such as EnCana and Total. With EnCana, they operate an equally-shared joint venture where EnCana contributes to upstream operations while ConocoPhillips is responsible for downstream operations. EnCana's operations include Foster Creek and Christina Lake whereas ConocoPhillips' undertakings include their Borger and Wood River refineries. Currently, production capacity is at 54,000

bbl/d. By 2015, production capacity will be increased to 400,000 bbl/d (Robertsen, 2008).

Partnering with Total, they both operate an equally-shared joint venture to develop steam assisted gravity drainage (SAGD) operations in the Surmont leases. Total contributes to the upgrading portion while ConocoPhillips is responsible for refining. In 2008, their target production rate was 25,000 bbl/d of bitumen. Further developments scheduled to be ready by 2012 will increase their production rates to 100,000 bbl/d of bitumen (Oil Sands Discovery Centre, 2009).

Petro-Canada

Petro-Canada operates a project in MacKay River, 60 km northwest of Fort McMurray. The design capacity of their operation is 33,000 bbl/d. The MacKay River Expansion project will add 40,000 bbl/d in as early as 2011. Production in Lewis Creek and Meadow Creek is expected to commence in 2017 with a potential to produce 113,000 bbl/d of oil (Oil Sands Discovery Centre, 2009).

Fort Hills was another Petro-Canada project. Fort Hills is a joint partnership between Petro-Canada (60 %), Teck Cominco (20 %), and UTS Energy (20 %). Petro-Canada operates the extraction and upgrading projects while Teck Cominco is responsible for the mining portion. Teck Cominco's operations are expected to be operational in 2011/2012 with a production capacity of 154,000 bbl/d (Robertsen, 2008). As a result of Petro-Canada's merger with Suncor, Fort Hills is now 60% owned by Suncor (Financial Post, 2009).

Canadian Natural Resources

CNRL (Canadian Natural Resources) operates a surface mining operation known as the Horizon Oil Sands Project covering 115,000 acres located 70 km north of Fort McMurray. Horizon's average production in 2008 was 110,000 bbl/d of oil.

CNRL also owns an in-situ operation known as the Kirby Project which is anticipated to produce 232,000 bbl/d of oil by 2012 (Oil Sands Discovery Centre, 2009).

Husky and British Petroleum

Husky and BP (British Petroleum) operate an equally-shared joint venture located 60 km northeast of Fort McMurray. Husky contributes to upstream operations with their Sunrise Project while BP is responsible for downstream operations with their refinery in Toledo, Ohio. Their Sunrise Thermal Project lease encompasses 42,000 acres with a daily production capacity of 200,000 bbl/d of oil by 2012. Husky also has operations in Cold Lake. In 2008, production from their Cold Lake Tucker Thermal Project was 2,000 bbl/d (Oil Sands Discovery Centre, 2009).

Devon Energy

Devon Energy fully owns and operates the Jackfish Project located 140 km south of Fort McMurray. The Jackfish Project utilizes in-situ technology was producing at a rate of 35,000 bbl/d of oil at the end of 2009 (Oil Sands Discovery Centre, 2009 and Devon Energy, 2010).

Nexen and OPTI

Nexen and OPTI operate an equally-shared joint venture located 42 km southeast of Fort McMurray. Nexen operates of the SAGD portion while OPTI contributes to the upgrading. There is approximately 40 years worth of reserves or two billion barrels of bitumen at Long Lake. The Long Lake Project is in-situ and will have a production rate of 58,500 bbl/d by the middle of 2010 (Oil Sands Discovery Centre, 2009).

StatoilHydro

StatoilHydro is a Norwegian government-owned energy company. In 2007, StatoilHydro acquired North American Oil Sands for \$2.2 billion. Their Kai Kos Dehseh demonstration project is anticipated to be completed in 2010 with a production capacity of 20,000 bbl/d. With other projects in the planning stages, StatoilHydro will eventually reach a peak production rate of 220,000 bbl/d scheduled to occur in 2016 (Robertsen, 2008).

Suncor

Suncor operates surface mining and in-situ oil sands projects. Surface mining operations consists of their Steepbank, Millennium, and Voyageur mines. Combined these mines produce at a rate of 277,000 bbl/d of oil. Firebag is their in-situ project producing at 140,000 bbl/d of oil (Oil Sands Discovery Centre, 2009).

Syncrude

Syncrude is the largest oil sand producer operating only surface mining projects. These include their Base Mine, North Mine, and Aurora Mine. Syncrude is jointly owned by Imperial Oil (25 %), Mocal Energy (5 %), Murphy Oil (5 %), Nexen (7.23 %), Petro-Canada (12 %), Canadian Oil Sands (36.74 %), and ConocoPhillips (9.03 %). Syncrude owns 102,000 ha of leases. In 2007, Syncrude was producing 305,000 bbl/d of oil (Syncrude Canada Ltd., 2010).

Petrobank

The Whitesands Experimental Project is located 120 km south of Fort McMurray. The Whitesands Project is owned by Petrobank (84 %) and Richardson Capital (16 %). Whitesands utilizes a relatively new in-situ recovery process known as

THAI (toe to heel air injection). In spring of 2008, Whitesands was producing 1,800 bbl/d of partially upgraded bitumen (Oil Sands Discovery Centre, 2009).

1.3 Challenges

Of the 140,200 km² of oil sand deposits in Alberta, only 602 km² (equivalent to the size of Edmonton) has been mined as of March 31, 2009. This accounts for 0.4 % of the total oil sands area or 0.1 % of the total area of the province. Only approximately 10 % (174 billion barrels) is recoverable using current technology, leaving a considerable amount of this valuable resource untapped (Alberta Energy, 2009).

The purpose of this thesis is to address this knowledge gap by developing a conceptual method to recover remaining oil sand deposits at intermediate depths, on the order of 300 m.

1.4 Layout of Thesis

The remainder of the thesis is structured as follows:

Chapter 2 (Literature Review) provides a review of various mining techniques and technologies, and background on the technologies used in the oil and gas industry.

Chapter 3 (System Concept) describes the basic workings of the proposed novel oil sand production method. Some technical considerations are provided along with a cost estimate.

Chapter 4 (Experimental Setup) gives the context for an experiment for an experimental study on cutting oil sand, outlines the variables that were

investigated, and explains how the devices were instrumented. As well as focuses on the custom-made oil sand blocks with an emphasis on how the blocks were made and characterized. The various options that were considered and the technical issues that were encountered are discussed.

Chapter 5 (Results and Discussion) presents and discusses the results of the various tests that were conducted. The tests included: shear testing, the Dean-Stark extraction test, porosity measurements, scanning electron microscopy, thermal imaging, digital microscopy of the tool tip, and fragmentation tests.

Chapter 6 (Conclusions and Recommendations for Future Work) summarizes the main results of the work carried out in this thesis, offers some conclusions, and recommends further work in this area.

Chapter 2 Literature Review

2.1 Introduction

An investigation was initiated into subterranean methods to fragment and transport oil sand to the surface in the form of a slurry. An initial examination was made of current enhanced oil recovery methods and conventional mining techniques. Elements from these methods and techniques were used to develop a system concept for slurry production from an oil sands deposit with an overburden covering of several hundred meters depth. This chapter describes the candidate technologies and critiques their applicability for mining oil sand as well as providing direction on technology development required in order for underground mining of oil sand to be possible.

2.2 Drilling Mechanisms

This section examines mechanisms associated with drilling and excavating ore, and will provide a brief background on the various techniques that can be used to access an ore body. Maurer (1968) described eight mechanisms; mechanical energy, thermal energy, liquefaction, chemical energy, sonic energy, hydraulic forces, electrical energy, and light energy. These were examined for their applicability in an oil sands mining environment.

2.2.1 Mechanical Drilling Methods

Plastic yielding or brittle fracturing of rock or soil occurs when imposed stresses surpass the tensile or shear strength of the ore or overburden. A cutting tool puts

normal and shear stresses on the medium. Beyond a certain stress, a failure plane develops in the medium, typically at the tip of the tool. Mechanically induced stress can come from a cutting tool, by impact, or by abrasion

Impacts are generated from percussion tools, explosions, or implosions. These impacts produce a zone of finely crushed rock directly beneath the area of impact. Fractures are induced around this crushed zone if adequate force and energy are exerted on the ore. These fractures propagate along curved trajectories to the rock surface, breaking loose chips or fragments of ore.

Abrasion is the process of wearing down or rubbing away by means of friction. Abrasion devices utilize hard, particulate materials such as tungsten carbide or diamond to cut ore. At the microscopic level, the tungsten carbide or diamond particles move parallel to the ore surface, producing a crushed zone ahead of the ore while forming a groove in the ore. Given sufficient cut depth, fractures will propagate along curved trajectories from the drill bit tip to the rock surface while forming debris ahead of the bit (Maurer, 1968).

Explosive Drilling

Explosive drills can be used to drill depths of up to 4000 m. This method of drilling consists of a capsule containing two non-explosive liquids separated by a membrane. As the explosive capsule reaches near the bottom of the hole, the membrane is broken and the two fluids mix to form an explosive mixture.

Explosive drilling is not a viable option for oil sand mining because of the nature of oil sand at subterranean depths. Research has shown certain material, such as clay, have an adverse effect on the drilling rate. This is due to the fact that clay yields plastically and is hard to remove from the borehole. Also, broken rock acts as a cushion thereby lessening the effects of subsequent explosions. However, crushed rock can be removed by subsequent explosions or by mechanical reaming (Maurer, 1968).

Implosion Drilling

Maurer (1968) briefly mentioned implosion drilling which involves injecting airtight capsules into the borehole. Once the capsule impacts the bottom of the borehole, the hydrostatic pressure in the well causes implosions in the collapsing cavern, thereby creating high-pressure pulses that impact and break rock.

Implosion drilling is not a viable option for oil sand mining because the required maximum drilling depth (300 m) is too shallow. Implosion drills are effective for deep (2000 m) wells where fluid pressure is higher.

Continuous Penetrator Drilling

Another drilling technology Maurer (1968) introduced was a continuous penetrator. This device crushes rock and discharges it into a zone surrounding the borehole, where a smaller penetrator can be used to ream out the zone of crushed rock mechanically or hydraulically. An advantage of a continuous penetrator is that there is no need to remove the entire drill string to replace worn or damaged components. Another benefit is that no circulating fluid is required to remove cuttings; however, a circulating fluid will be required to remove crushed rock from the borehole. Continuous penetrators do not appear to be a viable option for oil sand mining, because the weight of the penetrator may actually compact the oil sand as oppose to fragmenting it.

Pellet Drilling

Pellet drills use metal spheres as projectiles to impact and break rock. The spheres are re-circulated through the drill bit once the spheres impact the bottom of the borehole (Maurer, 1968). Pellet drilling is not likely a viable option for oil sand drilling, for two reasons: the method has poor reliability where rapid failure of equipment may occur due to erosion from the steel spheres, and the oil sand

may not fragment into lumps of suitable size that are amenable for slurry transport to the surface.

Turbine Drilling

Turbine drills consists of a turbine rotating a diamond reamer at 5,000 – 10,000 rpm. The drill string is rotated at 30 – 75 rpm to ensure a hemispherical contour in the borehole (Maurer, 1968). Turbine drilling is not a viable option for oil sand mining due to its insufficient drilling rate. For example, for a 20 cm diameter hole, Maurer (1968) indicated a conventional rotary drilling rate (4.2 m/hr) was twice as fast as turbine drilling (2.4 m/hr). Also, turbine drills have the same power output as rotary drills (20 – 60 hp), but have drilling rates that are twice as slow.

Rotary Percussive Drilling

A rotary percussive drill consists of a piston impacting a chuck which transmits the energy to the bit. This type of drill has many advantages such as low capital costs, versatility (such that it can be applied to any type of rock and can have a wide range of diameters), and is simple to maintain.

This type of drilling can be subdivided into two categories; top hammer and down-the-hole hammer. Rotation and percussion are the two basic actions of a top hammer drill. The two actions are produced outside the borehole, where the shank adaptor and shaft transmit the energy to the bit. The hammers can be pneumatically or hydraulically driven. In down-the-hole hammer drilling, the rotation is produced outside the hole, while the percussion is transmitted directly to the bit. The piston is pneumatically driven, whereas the rotation can be pneumatically or hydraulically driven. Hilliard (1997) describes rotary drilling in more detail. Rotary percussive drilling is not a viable option for oil sand mining due to the following reasons:

- Efficiency is dependent on too many factors:
 - Kinetic energy from the percussive action of the piston is transferred to the bit producing work, while some of the energy is reflected back to the shaft.
 - Kinetic energy is also lost across the rod coupling sleeves because of friction and reflection which is transformed into heat and wear on the drill threads.
 - Therefore, it is difficult to quantify this efficiency loss since it depends on bit design, material of the drilling equipment, shape and size of the piston, rock type, etc.
- Difficulty in determining optimum thrust load:
 - Inadequate thrust loads result in loosening and heating of the drill threads, higher sleeve and rod wear, and lower drilling rates.
 - On the contrary, if thrust loads are too high; the borehole can deviate, there is an increase in drill bit wear and vibrations as well as rotation resistance, there is a possibility of the drill jamming, and lower drilling rates may result.

Overburden Drilling

Overburden is defined as layers of gravel, sand, clay, rock fill or compact/non-compact materials. Overburden drilling is a specific type of drilling technique used to drill through altered or unconsolidated masses, rocky ground or overburden. Overburden drilling is used where borehole stability is required which is accomplished with casing tubes. This type of drilling involves the sinking a drill casing through the overburden to where it meets the underlying rock. A rotary percussion drill hole is then continued to the desired depth. While the casing is being sunk through the overburden it is coupled to the drill rod and rotates with it. The bit on the end of the drill rod projects about an inch beyond the end of the ring bit with which the casing is fitted and acts as a pilot bit for the casing bit (Hilliard, 1997). Overburden drilling is not a viable option for oil sand

mining because of its limited drill depth. Maximum drill depth is limited 100 m due to the size of the casing tubes, and the ability of the drilling and flushing system.

Raise Boring

Raise boring is used for making a shaft or a circular hole between two levels in an underground min. In standard raise boring, a borer is assembled and arranged on the upper level and a pilot hole is drilled down to the lower level. Once the pilot hole reaches the lower level, the drill bit is replaced with a reamer bit of the specified diameter of the shaft. Then, the reamer bit is raised up towards the upper level. Pilot hole diameters are in the range of 200 – 250 mm, while shaft diameters can be 1 – 6.3 m (Jimeno et al., 1995).

There are three types of raise boring; standard, reversible, and blind hole. Standard raise boring is the most common setup used. In reversible raise boring, the borer is placed on the lower level and the pilot hole is drilled to the upper level. Blind hole raise boring is similar to reversible raise boring, but no pilot hole is drilled.

Raise boring requires an underground network of tunnels to be in place so that the equipment can be brought in and setup. Raise boring is not a viable option for oil sand mining because this technique is an entry method which requires operators to be underground. This was deemed to be a safety concern due to the structural stability of oil sand and regulatory issues with placing miners below the surface.

However, a variant of reverse raise boring could be developed by drilling a pilot hole using a drill string that includes boring equipment in the drill string, or to deploy the borer by connecting to a second drill string carrying the boring equipment, using remote tooling rather than personnel. Either of these variations on the raise boring method would require extensive technology development

Cable Tool Drilling

In cable tool drilling, a bit or an impact tool is hung from a steel cable over a borehole. The bit is repeatedly dropped to pulverize the rock. To collect the cuttings, a bailer may be used or the bit is equipped with a bucket along the side of the tool to collect the cuttings. After multiple impacts, the cable is retracted so that the bailer is can be lowered to retrieve the cuttings. Once the bailer is removed, the bit is lowered back into the borehole for the process to be repeated. In order to save a step, the bit can be equipped with a bucket instead of a bailer. For more information on cable tool drilling, the reader is advised to refer to Hilliard (1997). Cable tool drilling is not likely to be a viable option for oil sand drilling due to the limited maximum depth and slow rate of penetration, due to the time required to retract and redeploy the bit.

Auger Drilling

Auger drilling uses a helical gear (Archimedes' screw) to drill into the formation. The blades of an auger drill remove the ore without the need for compressors, pumps, or a circulating fluid (which can contaminate the ore). Auger drilling is inexpensive (low capital and operating costs) and is primarily used in unconsolidated formations and soils. There are four types of auger drills; continuous flight, hollow, short flight and plate, and bucket. Continuous flight augers have helical gears on the entire shaft. Hollow augers are continuous flight augers with a hollow centre tube. Short flight and plate augers have helical gears on part of the shaft where cuttings loaded on their blades. Then, the auger is hoisted to the surface where the cuttings are spun off. Bucket augers have buckets which collect the cuttings. A comparison of the auger types are found in the following table.

Table 2-1 Auger comparison

Type of Auger	Application	Advantages	Disadvantages
Continuous flight	Site investigations, mineral sampling	Inexpensive	Drilling difficulties in coarse formations and heaving sands
Hollow	Mineral exploration	When hard rock is encountered, a diamond drilling core can be inserted into the tube	
Short flight and plate	Creating access holes, mineral sampling	Large diameters	Water in the hole removes the cuttings from the auger blades
Bucket		Large diameters, drills below water, functions in holes filled with mud	Limited depth

Hilliard (1997) discusses auger drilling in greater detail. Auger drilling may be a viable option for oil sand mining, but only if the torque loss challenge can be solved. At intermediate depths on the order of 300 m, the torque generated at the top may not be completely transmitted to the bottom, because the screw engagement against the wall of the drilled section creates friction along the length of the auger string, thereby causing twisting or bending and eventual failure of the auger.

2.2.2 Thermal Energy Drilling Methods

The next drilling mechanism that Maurer (1968) described is drilling via thermal energy. Heat generates thermal stresses that can degrade and fracture ore. These stresses are a result of spallability (differential thermal expansion of the crystals) and grains in an ore body. Spallability can be attributed to:

- Chemical reactions causing breakdown of the mineral.

- Heating of liquid or gaseous inclusions.
- Removal of water of crystallization (water that occurs in crystals but is not covalently bonded to a host molecule or ion).
- Phase changes in minerals.
- Differences in thermal expansion coefficients among the different minerals.
- High-temperature gradients in the ore body.

Maurer (1968) introduced six novel drilling methods based on thermal energy. These methods were analyzed for their applicability in an oil sands environment and are discussed below.

Induction Drilling

Induction drills operate on the basis of heating and breaking rock by inducing a high-frequency magnetic field to rocks that are magnetically responsive. The magnetic field generates eddy currents and heats the rock by hysteresis (re-magnetization losses) creating differential thermal expansion and high thermal stress which breaks rock (Maurer, 1968). Induction drilling is not a viable option for oil sand mining because oil sand is not magnetically responsive.

Microwave Drilling

Microwave drills consist of magnetrons producing 1000 – 3000 MHz microwaves projected onto the rock. Dielectric losses quickly heat and eventually break the rock (Maurer, 1968). Microwave drilling may be a viable option for oil sand mining depending on the size of the broken pieces

High-Frequency Electric

High-frequency electric drills operate on the basis of heating rock by resistance and dielectric heating using high-frequency electric fields. Resistance heating is a

result of current traveling through the rock, and dielectric heating is caused by the friction between the dipoles switching back and forth (Maurer, 1968). High-frequency electric drilling may be a viable option for oil sand mining depending on the size of the broken pieces.

Terra-Jetter

The terra-jetter is a specific type of drill patented by Ross (1964) which operates on the basis of cyclically heating and supercooling rock using superheated steam and liquid nitrogen. Steam (250 – 500 °C at 40 – 60 kg/cm²) would heat the rock to approximately 300 °C in 3 min. Afterwards, liquid nitrogen (- 196 °C) would be discharged on the heated rock causing thermal shock and breaking the rock. However, it may not even be necessary to cool the oil sand, given that the bulk modulus of oil sand reduces when temperature rises. A breaking method would still be required for interburden (Maurer, 1968). A terra-jetter drill may be a viable option for oil sand mining depending on the thermal conductivity of oil sand.

Electric Disintegration Drilling

Electric disintegration drills operate by using temperature gradients to create thermal stresses, resulting in spalling and breaking of rock. A 60 Hz high voltage electric current is emitted into the rock (Maurer, 1968). Drilling by electric disintegration is not a viable option for oil sand drilling because this type of method is restricted to drilling ore with high electrical conductivity (iron ore), or for drilling porous rocks impregnated with an electrolyte (water).

Forced-Flame Drilling

Forced-flame drilling uses nitric acid as an oxidizing agent for fuel oil to heat and spall rock, while water cools the combustion chamber and the burning nozzles.

The water also solidifies the molten rock while producing steam which helps remove rock debris (Maurer, 1968). Forced-flame drilling is not a viable option for oil sand mining because the high flame temperature may negatively alter the composition of the bitumen.

Jet-Piercing

Jet-piercing drills are similar to forced-flame drills with the exception of the oxidizing agent – this type of drill uses oxygen instead of nitric acid (Maurer, 1968). Jet-piercing is not a viable option for oil sand mining because the high flame temperature may negatively alter the composition of the bitumen.

2.2.3 Liquefaction Drilling Methods

Another drilling mechanism that Maurer (1968) described is drilling via liquefaction. Drilling technologies utilizing this mechanism is discussed below.

Plasma Drilling

Plasma drills can generate 20,000 °C ionized flames by passing an electrical current through a high speed (200 – 8000 m/s) inert gas (helium or argon) flowing between two electrodes (Maurer, 1968). Plasma drilling is not a viable option for oil sand mining because the high flame temperature may negatively alter the composition of the bitumen.

Nuclear Drilling

Adams (1965) patented a nuclear drilling method capable of melting or fusing rock. First, an unshielded instrumented nuclear reactor is placed in a shallow hole. Heat output from the reactor melts the underlying rock while the reactor sinks through the resulting magma due to the difference in densities (the average

density of the reactor is greater than the density of the magma). However, nuclear drilling is not a viable option for oil sand mining due to safety concerns regarding radioactive material and the public acceptance of nuclear power. Also, this method does not address the fact on how the melted ore will be transported to the surface which is a requirement in an oil sands application where the reservoir material must be recovered for processing.

Electric Heater Drilling

An electric heater drill uses an iridium or tungsten resistance wire surrounded by boron nitride to heat the drill tip to 1200 – 1600 °C. A downward thrust causes the molten rock to travel up the center of the drill while a high-speed stream of helium gas solidifies it forming particles that are blown from the borehole. Water is used to cool the drill (Maurer, 1968). Electric heater drilling is not a viable option for oil sand drilling unless the temperature is controlled to prevent negative alteration of the composition of the bitumen.

Electric Arc Drilling

Electric arc drills emit a continuous electrical current through a conducting gas between two electrodes, and can operate at lower temperatures (5000 – 20,000 °C) than plasma drills (Maurer, 1968). Electric arc drilling is not a viable option for oil sand mining due to its inefficiency at fluid-filled boreholes. Specifically, Maurer (1968) stated that 5 kJ/cm³ is required to fuse sandstone in air whereas 100 kJ/cm³ is required when the sandstone was submerged underwater.

2.2.4 Chemical Energy Drilling Methods

There are a variety of chemicals that can be used to dissolve various types of rock. Chemical drills use highly reactive chemicals such as fluorine or another halogen to yield high-speed reactions with the rock. These reactions occur in a violent

manner and are severe enough to set fire to asbestos while producing harmless byproducts that can be easily removed. Maurer (1968) indicated that lab tests have shown that these chemicals can easily liquefy granite, sandstone, and limestone. Chemical drilling is not a viable option for oil sand mining because of the high cost of chemicals, handling difficulties, and the slow rate of penetration. Chemical drills are used on a wireline. Therefore, the tool would have to be lifted from the borehole, refilled, and then lowered back into the borehole.

2.2.5 Sonic Energy Drilling Methods

Sonic drills were briefly mentioned by Maurer (1968). Ultrasonic instruments are used to drill and machine hard alloys, ceramics, and diamonds. They can also be used to drill rock. Ultrasonic drills use electrostrictive or magnetostrictive cores causing emitters to vibrate at 20 – 30 kHz. A variable magnetic field causes the core to expand and contract at amplitudes of several microns. The amplitude is amplified 10 – 100 times by a resonant tapered horn located in between the magnetostrictive transducer and the cutting tool. The vibrating cutting tool removes rock by abrasion and cavitation. Ultrasonic drilling is not a viable option for oil sand mining because of its low drilling rate (from 0.1 cm/min drilling through tungsten carbide to 2.0 cm/min for drilling through soda glass) and high energy requirement. Based on a power output (from the drill to the ore) of 90 W and a hole diameter of 1.2 cm, the specific energy requirements range from 19,000 J/cm³ (drilling through quartz) to 120,000 J/cm³ (for sapphire) whereas conventional drills require 100 – 300 J/cm³.

2.2.6 Hydraulic Forces

Erosion is a process that results from wearing or weathering as particles move over a medium. Erosion jetting can be classified into two categories; low-speed and high-speed. Low-speed jetting occurs at 10 – 200 m/s and use sand or other

abrasive particles to impact and remove the ore. High-speed jetting occurs at 200 – 1000 m/s and use water to erode the ore. Jetting at this speed requires pressures up to 5000 kg/cm² which can penetrate the hardest rocks. High-pressure jetting is equivalent to a series of solid projectiles impacting the surface of the ore resulting in lateral expansion or crack propagation of the surface. When a high-pressure jet is aimed at a fracture in an ore, there is sufficient pressure applied to the sides of the fracture causing the fracture to propagate throughout the ore. Also, a high-pressure jet can exert enough pressure on the sides of erosion-produced holes to dislocate chunks of ore. Erosion jetting requires significantly less energy to dislocate blocks of ore as opposed to drilling (Maurer, 1968).

Erosion Drilling

Erosion drills use high-pressure jets to drill and excavate rock. Power output increases with increasing nozzle diameter and fluid pressure, along with decreasing fluid density. Erosion drills have high power outputs and high potential drilling rates. To illustrate this, assume a drill has four 2 mm diameter nozzles operating at 4000 kg/cm² of pressure. The power output would be approximately 6000 hp. This is more than 100 times as compared to the 20 – 50 hp a large rotary drill can transfer to rock (Maurer, 1968). Despite this low efficiency, erosion drilling may be a viable option for oil sand drilling and mining.

2.2.7 Electrical Energy Drilling Method

Spark drills use high-voltage spark discharges to produce explosive-like pressure pulses. Tests show that 300 – 500 J/cm³ are necessary to drill sedimentary rocks, which is approximately double that of conventional drilling. Spark drills require more energy but produce higher drilling rates due to the potential power outputs of 100 – 200 hp as opposed to 20 – 50 hp for large rotary drills (Maurer, 1968). Spark drilling may be a viable option for oil sand mining.

2.2.8 Light Energy Drilling Methods

Laser drilling uses concentrated light beams with power densities in the range of 10^{12} W/cm² to fuse solids and drill rock. Laser drilling is not a viable option for oil sand mining because of its low drilling rate. A 1 kW laser would require 5 kJ/cm³ of energy to fuse a 1 mm diameter hole at 1500 cm/min. Realistically, a 1 mm diameter hole is not practical in terms of mining oil sand. Using the same parameters, in order to drill a more reasonable sized hole (20 cm diameter) would occur at 0.04 cm/min. This drilling rate is unacceptable since conventional drills operate at 2 – 100 cm/min (Maurer, 1968).

2.2.9 Applicability of Drilling Methods for Oil Sands Underground Production

To summarize, Table 2-2 briefly lists the various drilling technologies and whether or not if they would be applicable for oil sand recovery.

Table 2-2 Drilling technologies and their applicability for oil sand recovery

Mechanism	Drilling Method	Potential	No
Mechanical	Explosive		×
	Implosion		×
	Continuous Penetrators		×
	Pellet		×
	Turbine		×
	Rotary Percussive		×
	Overburden Drilling		×
	Raise Boring		×
	Cable Tool		×
	Auger		×
Thermal	Induction		×
	Microwave	×	
	High-frequency electric	×	
	Terra-jetter	×	
	Electric disintegration		×
	Forced-flame		×
	Jet-piercing		×
Liquefaction	Plasma		×
	Nuclear		×
	Electric heater		×
	Electric arc		×
Chemical	Chemical		×
Sonic	Ultrasonic		×
Hydraulic	Erosion	×	
Electrical	Spark	×	
Light	Laser		×

Twenty-six vertical drilling techniques, grouped under eight categories, were examined for their applicability in mining oil sand at intermediate depths. Mechanical drilling is the current method for oil sands. Techniques based on thermal energy (microwave, high-frequency electric, and terra-jetter), hydraulic forces (erosion), and electrical energy (spark) show promise, although power requirements, efficiency, costs, and reliability are difficult to assess given the disparate applications reported in the literature. The system concept will focus on using mechanical and hydraulic forces.

2.3 Horizontal and Directional Drilling

2.3.1 Introduction

Directional drilling is an established and commonly used drilling technique developed from a need to vary the direction of a drill string from a straight vertical or slant drilling operation, to bypass lost drilling tools instead of drilling a new hole, or to access reservoirs. Ultimately, horizontal and directional drilling are used to increase well productivity by increasing reservoir contact area to allow production of oil and/or gas from formations that can not be produced economically by other means. For example, drilling multiple vertical wells for a reservoir with multiple vertical fractures is not neither economical nor efficient; however, drilling horizontally through multiple vertical fractures (maximizing lateral extension) would be economical. Considering a 1000 m horizontal well in a 10 m thick reservoir, the contact area is 100 times greater than that of a vertical well at that depth. In many cases, there is negligible pressure drop while moving a drilling fluid over a maximum horizontal distance of 1000 m. More information regarding pressure drop through a horizontal well can be found in Joshi (1991) and Aguilera et al. (1991).

2.3.2 Stages

The general steps involved in creating a horizontal well is to first start by conventional vertical drilling. Once required depth has been reached, angle building is commenced until the required horizontal depth is attained followed by horizontal drilling. The final stage is the completion state which involves casing and cementing the well. Chapter 3 of Aguilera et al. (1991) is dedicated to horizontal well completion.

2.3.3 Applications

Wright (1991) provided a list of applications where horizontal and directional drilling are typically used for. These include:

- Accessing reservoirs that are inaccessible by vertical drilling.
- Areas where building surface infrastructure would be too expensive or challenging, such as offshore drilling.
- Reservoirs with multiple vertical fractures.
- Reservoirs with thin (< 50 ft) pay zones.
- Reservoirs that are uneconomical to drill with vertical drilling.
- Re-entering oilfields that were depleted by vertical drilling.
- Accessing environmentally sensitive areas.

Other uses for horizontal and directional drilling include EOR techniques such as SAGD since a larger area of the production liner is exposed to the formation. This will result in: increased gravity drainage efficiency and injectivity, improved sweep efficiencies, and reduced number of wells required for steam injection or waterflooding.

2.3.4 Costs

Well costs for horizontal and directional drilling are project specific. The more difficult the well is to drill, the more cost prohibitive it becomes. Taking a vertical well as a reference, a long radius horizontal well will cost double the amount. Also, Fritz (1991) reported that the cost for a horizontal or vertical well increases exponentially as depth increases. Butler (1994) concluded that generally, the cost of a horizontal well is approximately 1.4 times higher to that of a conventional well. The higher cost is acceptable because of higher production rates and the number of pads (drilling sites) saved. Currently, it costs on the order

of \$2000/m to drill and cement a 16 in diameter hole with a horizontal of 1000 m (B. Speirs, personal communication, November 17, 2009). Well costs will continue to decrease over time as more familiarity is obtained from drilling multiple wells and as technology matures. A cost estimate for the system concept is presented in later chapters.

2.3.5 Benefits

Directional drilling has numerous advantages which include:

- Greater access to a reservoir.
- Drilling multiple wells from one site. For example, in areas such as offshore platforms or densely forested remote areas (jungles, swamps), it would be more cost effective to drill horizontally instead of building new infrastructure (roads, drilling pads/platforms) for multiple vertical wells. Operational and labour costs would also be reduced since production facilities would be in one central location and there would be no need to transport or store equipment at various locations.
- Since production is proportional to the contacted reservoir area (production liner), directional drilling will yield an increase in production approximately 3 – 5 times that of vertical wells due to an increase in flow area within the pay zone. Production is greatly improved with horizontal drilling. For example, in 1987, Esso Resources Canada reported a production increase from 3,000 – 28,300 bbl/d at their Norman Wells site with a horizontal length of 4,013 ft (Butler, 1994).
- Theoretically, based on pseudo steady-state flow, horizontal wells are capable of productivities of up to 10 times greater than that of vertical wells. This statement applies to long-radius wells in a thin reservoir with good vertical permeability. Pseudo steady-state is a result of a pressure disturbance generated by the producing well which is detected at the boundary of the drainage area of the well. This phenomenon is discussed in further detail in Joshi (1991). Well productivity is simply flow rate

divided by pressure drop and is explained in Joshi (1991). Chapter 6 of Aguilera et al. (1991) provides a more rigorous definition of well performance and productivity.

2.3.6 Future Developments

As technology advances, some future developments in horizontal and directional drilling include:

- Smaller diameter (< 4 in) MWDs for smaller diameter holes.
- Sensor development so that MWDs can be equipped with more sensors.
- MWDs integrated with drilling tools that can log tool-face data.
- MWDs and other drilling tools that can tolerate higher temperatures.
- Larger diameter coring systems.
- Enhanced drill bit designs to eliminate problems with sideloading, reduced bit life, and stalling. Problems begin to occur when changing from vertical to horizontal. Sideloading occurs when impact stresses develop on the lower periphery and across the bit face.
- Cuttings removal
 - Drilling fluids are designed to have increased suspension properties, such as biopolymer fluids. Suspension properties of a drilling fluid/mud move cuttings away from the bit which allows for greater cementing and reduces friction yielding less torque and drag between the drill pipe and the hole, thereby reducing the power consumption and the likelihood of seizing. The drilling fluid also prevents hole collapse by providing pressure.

The driving force behind research and development is to reduce costs in exploration, development, and production. The result is to make uneconomic reservoirs competitive with conventional crude oil reserves.

2.3.7 Horizontal Drilling for Thermal In-Situ Production Methods

The fundamentals of horizontal and directional drilling can be applied to EOR techniques such as SAGD and CSS, both of which are briefly discussed in this subsection.

Development

SAGD was developed by Imperial Oil, for heavy oil recovery at their Cold Lake operations. The approach is similar to salt mining by solution, where fresh water is injected into a cavern by which cavities are formed as the salt and its walls dissolve. Note, when salt is mined, conventional vertical wells are used. The brine (water saturated with salt) falls along the surface, and is collected by a well below. Conventional wells are not used for SAGD because of uneconomical production rates compared to more favourable rates with horizontal wells. With SAGD, steam is injected into the formation to form a steam chamber, where it condenses at the surface of the chamber, thereby heating the formation. The heated bitumen and the condensate flows downwards by gravity to the surface of the lower well where collection occurs. SAGD can simply be viewed as gradually melting layers of bitumen. A successful field pilot was constructed in 1978 at Imperial Oil's Cold Lake facility.

Introduction

SAGD is a thermal-based EOR technique that was developed to economically recover oil reserves from oil sand. Surface mining is used to access oil sand at shallow depths (0 – 150 m). At increasing depths, surface mining becomes uneconomical. This is where an in-situ thermal recovery method, such as SAGD is deployed.

Requirements

According to Butler (1994, 1997), in order to use thermal-based recovery methods with horizontal wells, the following requirements need to be satisfied:

- Well spacing
 - Close well spacings are necessary. Generally, 2½ – 5 acres of land per well pair is required.
- Viscosity
 - Drainage rates depend on the viscosity of the bitumen and the characteristics of the reservoir. In order to achieve desirable recoveries, the viscosity must be lowered (by heating or by other means) to allow more viscous flow.
- Drilling
 - SAGD requires two horizontal wells with a vertical distance of 15 ft with laterals of more than 1500 ft.
- During operation
 - Uniform steam injection throughout the lateral must be maintained to ensure economical sweep efficiencies.
 - To obtain economical process efficiencies, the volume of steam injected must be constant to the steam lost.
 - Injection rates must be the same as production rates to ensure efficient operation.
 - Steam injection must be kept within ± 5 psi, otherwise performance will suffer.

Well Configurations

SAGD uses two horizontal wells; a horizontal injector well, and a horizontal producer well. The injector well produces steam causing hot oil to flow down to the producer well by gravitational forces. There are various injector-producer

well configurations, such as those mentioned in Butler (1994) and Aguilera et al. (1991). The most common configuration, the horizontal injector-producer will be discussed. In this arrangement, the steam injector is placed closely above the producer. As the steam rises, it forms a steam chamber (shaped similar to an inverted tear-drop) growing from the injector well, and the heated oil flows downwards to the producer well. Placement of the injector and producer depends on the formation. But, usually the injector is placed approximately 15 ft above the producer so that the oil in the reservoir between the two wells can be heated and mobilized by conduction. This assists in initiating the SAGD process.

Costs

According to the Alberta Chamber of Resources (2004), for a SAGD operation with high-quality reserves (steam/oil ratio of 2½:1), the variable recovery cost is approximately \$7.40/bbl, while surface mining is estimated at \$8.00/bbl. Capital costs for both surface-mined bitumen and SAGD-recovered bitumen (mostly due to drilling) is \$3 – \$4/bbl, amortized over the life of the operation. Operating expense is \$18 – \$22/bbl.

Aguilera et al. (1991) reported the advantages of SAGD include:

- Increased productivity relative to the number of wells drilled.
- Increased oil/steam ratio (the amount of oil produced to the amount of steam injected).
- Increased ultimate recovery.
- Decreased sand production.
- Recovery is 40 – 70 %.
- The produced oil can be treated in conventional downstream refineries as opposed to mined bitumen where multiple extra stages are required to prepare the bitumen for refining.

Some disadvantages of SAGD were also discussed by Aguilera et al. (1991).

These are:

- May not be suited for reservoirs with low vertical permeability.
- The maximum lateral is restricted by the steam pressure drop. More information regarding pressure drop through a horizontal well can be found in Joshi (1991) and Aguilera et al. (1991).
- Sufficient cap rock is required.

As well, steam to oil ratios may be higher than predicted, which adds to costs, and may reduce the amount of oil produced from a well.

Challenges

As steam is injected into the reservoir, the steam chamber will continue to grow and will reach the surface of the reservoir in 1 – 2 years depending on the injection rate and reservoir formation. Once the steam chamber reaches the surface, heat loss will occur from the rising steam, and the chamber will disperse sideways. Sealing the top of the reservoir with a cap will prevent heat loss and steam dispersion. SAGD is not suitable in situations where the top of the oil is exposed to the atmosphere within the porous matrix. SAGD maybe used in this scenario only if the steam is below atmospheric pressure. In this case, if steam is injected in these reservoirs, the steam will be lost above the oil and will result in ineffective heating of the formation, even if the steam does not breakout to the surface. It is theoretically possible that SAGD could be used in these cases if the steam pressure is set at or marginally below atmospheric pressure. However, this will necessitate the production well to function under a vacuum.

2.3.8 Cyclic Steam Stimulation

CSS was accidentally discovered in 1959 by Royal Dutch Shell at the Mene Grande Field in Venezuela. CSS uses a single well, with injection and production stages occurring one after the another. First, the steam is injected and allowed to soak

for several weeks, and then oil production begins. Once production declines, this cycle is repeated until unfavourable economics (the cost of steam injection exceeds the cost of the oil produced) precipitate. CSS can also be referred to as huff and puff, steam soaking, and steam stimulation. Steam injection causes a pressure rise in the reservoir. During the production stage, reservoir depressurization occurs resulting in fluid displacement. CSS can be used in conventional or horizontal wells. However, Aguilera et al. (1991) reported that a horizontal CSS well recovered approximately double the amount of oil compared to a vertical CSS well. Also, in an anisotropic reservoir, a horizontal CSS well recovered 1½ times the volume of oil compared to a vertical CSS well. Anisotropic reservoirs have different properties depending on the direction measurements are taken which is due the reservoir's strata. Therefore, the discussion of CSS will focus on a horizontal well setup.

Requirements

The success of CSS depends on the uniform distribution of steam along the horizontal section. Similar to SAGD, CSS performance depends on the vertical permeability of the reservoir.

Production

Bitumen production by CSS is efficient and economic. In Cold Lake, oil is produced at 70 bbl/d per well. This is equivalent to 25,000 m³/well (157,000 bbl) (Butler, 1994).

Limitations

The main drawbacks are that close well spacing is required (similar to that of SAGD) and recovery is low (15 – 20 %). Various companies have tried using CSS in the Heavy Oil Belt. But, their attempts were considered technical failures.

Their difficulties were a result of geotechnical issues and low thermodynamic efficiencies (high steam/oil ratios). Dusseault (2002) briefly expands on these challenges.

Applicability

CSS as a process by itself, is not considered to be a good candidate for an EOR application because in order to obtain high sweep efficiencies, the steam injection volume should be equal to the volume lost. However, CSS may be used to initiate SAGD.

2.3.9 Application of Horizontal and Directional Drilling for Oil Sands Underground Production

Directly using horizontal or directional drilling will not be feasible for mining oil sand at intermediate depth because of the limitations associated with transporting oil sand to the surface in the form of a slurry. However, the concepts behind horizontal and directional drilling can be taken and applied in the context of mining oil sand. For example, low-pressure SAGD which is a variant of SAGD may be possible at intermediate depths of around 300 m. On the contrary, if SAGD or CSS is to be used, methods to provide sufficient cap over the formation will need to be investigated. It should be noted that the systems used for horizontal and directional drilling may be carried over or modified to meet the given context, such as cuttings removal.

2.4 Fracing

2.4.1 Introduction

According to Hibbeler (2005), fracing is a common well stimulation technique invented in the 1950s. It is used in low-permeability oil and gas formations to

increase recoverable reserves or to accelerate production rates by increasing the flow of hydrocarbons to the well by creating fractures in the formations and making existing fractures larger. These fractures increase the effective permeability and changes the path of fluid flow. Fraccing lowers the number of extraction wells thereby reducing material costs and labour.

There are two types of fraccing; pneumatic and hydraulic. Pneumatic fraccing injects a highly pressured gas or air into the formation, whereas hydraulic fraccing injects a fluid. Hydraulic fraccing, or simply fraccing, will be discussed.

Fraccing involves specially engineered fluids being pumped into a closed borehole with high-pressure hydraulic pumps to create enough pressure to fracture the formation. The injection pressure required to create fractures is usually less than 100 psi for depths of 5 ft. However, higher pressures are necessary for greater depths. Shallow fraccing applications are usually 3 – 20 ft deep (Hibbeler, 2005).

2.4.2 Applicability

Fraccing is commonly used for hard rock formations where natural permeability is insufficient to allow adequate movement of fluids such as formations with permeabilities less than 2 md. Formations such as shale, limestone, siltstone, sandstone, or any combinations of clay and sand, silt and sand, or silt and clay are usually suited for fraccing. Fraccing a sand or gravel formation is not justified as the benefits from the increase in permeability will not meet the cost of the process. According to Bradford (2004), there is low demand for fraccing in locations where heavy oil and oil sand are dominant.

2.4.3 Procedure

In a fracking operation, a borehole is first drilled to a specified depth. Then, high pressure fluid is used to cut a disc-shaped notch at the bottom of the borehole which acts as a starting point for the fracture. Next, a slurry consisting of fluid and proppant is pumped at high pressure to create a specific fracture. Finally, as the fluid degrades, it leaves behind a highly permeable proppant-lined fracture. The proppant prevents the fracture from collapsing.

2.4.4 Costs

Fracking produces some of the highest returns of any oilfield service. A crew consists of 10 personnel can generate approximately \$50,000 per day. The capital cost for a typical fracking crew's equipment is \$8.5 million where most of the cost is due to the blenders and pumpers (Bradford, 2004).

2.4.5 Geotechnical Considerations

Some geotechnical factors that should be considered when conducting a fracking operation are:

- Cohesion
 - The cohesiveness of the formation is directly proportional to the responsiveness of the formation to fracking. Formations that are cohesive tend to have fractures that remain open longer upon relaxation of the fracture stress. Fracking cohesive formations, such as a silt and clay combination, have been successful.
- Permeability
 - Fracking is commonly used in low-permeability formations where generally a greater fluid flow will result.
- Unconfined compressive strength
 - Is used to predict fracture and propagation direction and orientation.

- Grain size
 - Fracching can be applied to formations with any grain size. However, finer grained formations will yield the highest permeability.
- Soil moisture content
 - Fracching improves soil permeability. However, vapour flow is influenced by soil moisture.
- Plastic and liquid limits of soil
 - These are known as the Atterberg limits which characterize the plasticity of a soil. Fracching in plastic formations such as clays, will not be as effective than in brittle materials where fracture propagation is more susceptible. Table 2-3 illustrates the suitability of fracching given a certain soil condition.

Table 2-3 Fracching suitability

Soil Condition	Result
Natural moisture content < liquid limit	Suitable for fracching
Natural moisture content > liquid limit (liquidity index > 0)	Soil may liquefy under a sudden shock rendered during fracching

2.4.6 Applicability of Fracching to Oil Sands Underground Production

Fracching will not be a viable option for oil sand mining unless three major hurdles are overcome. First is the formation characteristics. Fracching is usually suited for hard rock formations or combinations of clay and sand, silt and sand, or silt and clay. Oil sand is a mixture of bitumen and unconsolidated sand. Fracching is ideal for tight formations which oil sand is not. The ability to operate a successful fracching operation will depend on the formation's ability for pressure containment. The second hurdle is viscosity. Fracching involves the use of proppants to create and sustain a fracture to allow for hydrocarbons to flow more readily into a well. Oil sand is too viscous to flow naturally in a fracture. Finally,

the interfacial properties of oil sand is not amenable for fracking because at the microscopic level, a drop of bitumen will enclose a sand grain. Fracking will not dissociate the bitumen drop from the sand grain.

2.5 Cold Heavy Oil Production with Sand

2.5.1 Introduction

CHOPS is a non-thermal EOR technique for vertical wells. CHOPS involves deliberate initiation of sand influx into a perforated oil well, and continued production of substantial quantities of sand along with the oil (Dusseault, 2002). In this method, progressing cavity pumps pump the oil from the sand resulting in the formation of high-porosity wormholes which allows more oil to flow into the borehole due to permeability effects in the reservoir, thereby increasing oil production. CHOPS consists of four major phases; sand influx during the completion stage, followed by maintaining sand influx during the operational life of the well, then separating the sand from the oil, and finally sand disposal.

2.5.2 Applicability

According to Dusseault (2002), CHOPS is applicable in cases where the reservoir's pay zone is in the range of 5 – 20 m with unconsolidated sand formations having high porosity ($\phi = \sim 35\%$) and high permeability ($k = 5 D$).

CHOPS is primarily used in Alberta and Venezuela. In Canada, CHOPS is used to produce approximately 650,000 bbl/day equivalent to 25 % of Canada's total production output. The majority of oilfield operations using CHOPS in Canada occur in the Heavy Oil Belt located around the Lloydminster area while bordering Alberta and Saskatchewan.

The Heavy Oil Belt varies in thickness from 5 to 35 m. This area consists of unconsolidated sandstone with porosities ϕ from 28 – 32 %, permeabilities k from 0.5 – 15 D, and viscosities μ from 1,000 – 20,000 cP making it ideal for CHOPS. Note that Athabasca oil sands has an average porosity of 36 % and a density of 2.1 g/cm³ with approximate grain sizes of 0.25 mm. Therefore, in order to use CHOPS in other reservoirs, formation characteristics should be similar.

It is believed there is 150 billion barrels of recoverable oil in this area. In Alberta and Saskatchewan, current heavy oil production from the Heavy Oil Belt is limited to approximately 460,000 bbl/d. This is due to the capacity limitation of heavy oil upgrading facilities in Canada and the mid-Western U.S. If these facilities were available, it is believed that 2 – 3 million bbl/d of heavy oil can be produced from the Heavy Oil Belt which could be sustained for at least 100 years because a number of old oilfields have only produced 5 % OOIP (Dusseault, 2002).

2.5.3 Benefits

Some of the advantages of using CHOPS were briefly introduced by Dusseault (2002). He stated that:

- CHOPS is more cost effective compared to thermal EOR methods (operating costs for a CHOPS operation equates to approximately \$7.00 /bbl).
- CHOPS by itself, is a useful EOR technique that can be used in reservoirs that are not appropriate for thermal EOR, such as SAGD. However, a combination of CHOPS and other heavy oil recovery methods may augment recovery. CHOPS may be used in conjunction with pressure pulsing technology or perhaps SAGD.

2.5.4 Limitations

Dusseault (2002) mentioned some of the limitations of using CHOPS. Specifically, CHOPS has a low recovery or about 5 – 6 %, while more than 20 % recovery is possible in some reserves. Also, for every cubic meter of oil produced, 30 – 40 kg of sand is generated along with 3 – 5 kg of emulsion. Finally, a substantial amount of waste is generated through the CHOPS process such as:

- Large amounts of oily sand containing 1 – 5 % oil by weight
- An emulsion of oil, chloride-rich water, and clays
- Sludge, asphaltenes, and fine-grained sand

2.5.5 Costs

From Dusseault (2002), the operating costs for a CHOPS operation equates to approximately \$7.00 /bbl. Waste handling is a major cost constraint for CHOPS. Handling the waste equates to \$3.00/bbl, equivalent to 15 – 35 % of the operating costs, depending on the rates of oil and sand generated. Work-overs are major overhauls performed on a well and their costs are another area of concern. Wells using CHOPS require more work-overs than conventional oil wells resulting in 15 – 25 % of the operating costs, depending on the properties of the oilfield and well.

Previously, it was more profitable and technologically easier to search for new conventional oil reserves rather than investing and developing new technologies and methods to recovering heavy oil. However, unless the price of oil is high enough, this mentality will change in the future as a result of increasing exploration costs for conventional oil. Since economics is a significant factor in any company, attention will be directed towards large reserves that are technologically difficult to process, instead of searching for diminishing conventional oil. Luckily, as current technology evolves and new techniques are developed, the relative costs of producing heavy oil will decrease.

2.5.6 Applicability of CHOPS to Oil Sands Underground Production

CHOPS is a proven technology that has been in use since 1982 at the Luseland Field located in Saskatchewan. CHOPS does meet the required depth that is under consideration. In the Luseland Field, CHOPS was used to a depth of 730 m. Therefore, CHOPS is a viable method for mining oil sand at intermediate depths (~ 300 m). However, the ultimate success of a CHOPS operation will depend on the reservoir characteristics such as the payzone thickness, viscosity, and lithology. CHOPS will be ideal for a reservoir with a payzone between 5 – 15 m with an in-situ viscosity of 12,000 – 30,000 cP and a lithology of uncemented quartz-rich sands. Note that Athabasca oil sands has an average porosity of 36 % and a density of 2.1 g/cm³ with approximate grain sizes of 0.25 mm. Therefore, in order to use CHOPS in other reservoirs, formation characteristics should be similar.

2.6 Mining

2.6.1 Introduction

Gertsch et al. (1998) present various entry-type methods for subterranean mining, where miners are required to go underground. This section examines the characteristics from various mining methods that may have potential for accessing oil sands at intermediate depths. The following figure lists the methods under investigation.

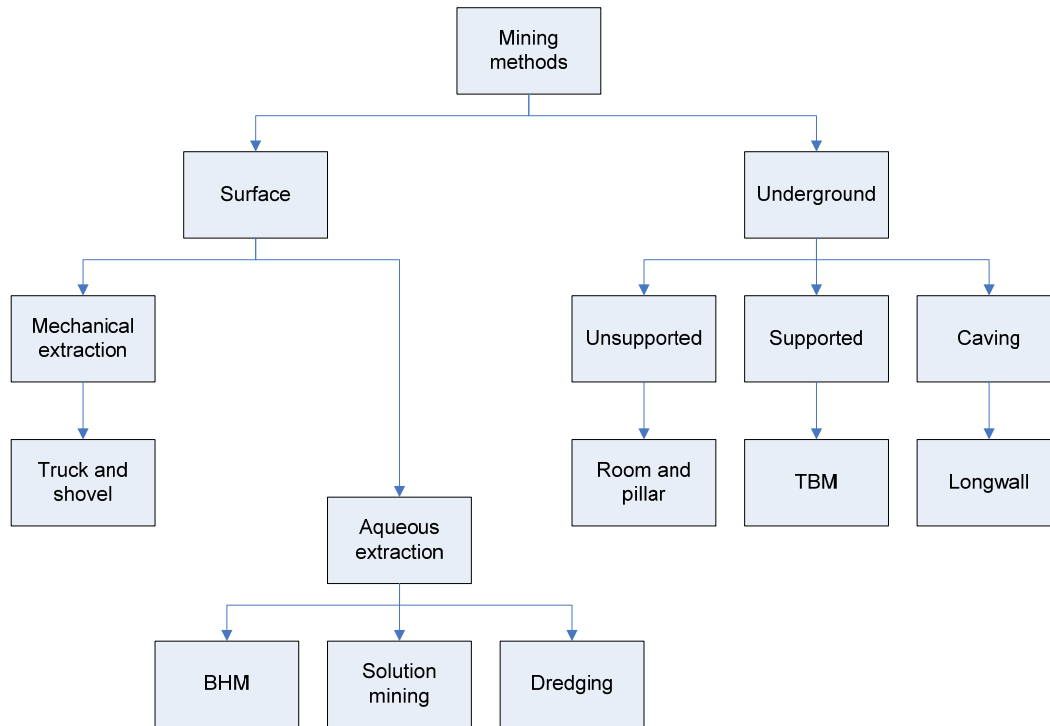

Figure 2-1 Classification of mining methods under investigation

2.6.2 Surface Mining vs. Underground Mining

When attempting to access ore on land, there are two choices: surface mining or underground mining. Selecting which method to use depends on how deep the deposit is located and how contiguous the ore is. For shallow deposits, surface mining would only need to be considered. For deep deposits, underground mining would be necessary. However, ore located at intermediate depths requires more careful consideration. In this situation, surface mining or underground mining may still be used or a combination of the two, where the mine starts off with surface mining techniques then continues on with underground mining methods.

Cost Comparison

The costs for surface mining are generally less than that of underground mining on a unit production basis. Hedberg (1981) stated that this is due to: larger equipment, lower capital intensity, simpler development, higher energy efficiency, less expensive auxiliary operations, and better health and safety factors. Some examples of equipment required for auxiliary operations for surface mining include: monitoring systems, waste disposal equipment, vehicles, etc. For underground mines, this will include: ventilation systems, conveyors, mine cars, etc. Hedberg (1981) reported that labour costs were five times higher for underground mines, that supply and material costs were 50 % higher, and that the overall cost of underground mining was four times higher than that of surface mining.

Selection Criteria

Both economic and technical factors are examined when deciding on which approach to take. For ore located at shallow depths, it can easily be concluded that surface mining is the most cost-effective solution. However, as depth increases, the cost of removing overburden increases exponentially. Once a certain depth is reached, surface mining becomes uneconomical (the cost of underground mining is less than the cost of surface mining) and/or unpractical (the stripping ratio of overburden to ore becomes too high for surface mining). Nilsson (1992) summarized his findings in the following points:

- Economical factors:
 - The net present value of the profit on the deposit must be the highest at the point of switching from surface mining to underground mining.

- If production rates remain unchanged, surface mining should cease when the cost of surface mining approaches the cost of underground mining.
- Geotechnical aspects:
 - Surface mining followed by underground mining is advised for deposits with steeply dipping veins or deposits with outcrops on the surface and extending to depth.
 - Either surface mining or underground mining, but not both, may be used if a deposit is located horizontally.

Hartman (1987) outlined a qualitative mining method selection procedure.

However, there are limitations to such a procedure, namely bias. In order to eliminate such bias, a quantitative analysis would be required which allows for faster, more complex, and objective evaluations to take place.

2.6.3 Underground Mining

When compared to surface mining, underground mining poses more challenges. In particular, economic constraints, technological limitations, and health and safety issues must be addressed. Once underground mining is selected, the choice of which technique to use depends on the geology of the formation and the extent of ground (roof) support required to ensure that the chosen technique is productive, economical, and safe. There are three categories of underground mining; unsupported, supported, and caving. These will be discussed in their corresponding sections of this chapter.

2.6.4 Mechanical Extraction

Mechanical extraction techniques account for 90 % of all surface mining production activities. Prior to the 1990s, surface mining oil sands involved draglines and bucket-wheels. During the 1990s, companies started using trucks

and shovels, resulting in increased reliability and lower costs. Draglines and bucket-wheels have the lowest cost in removing ore. But, have a high capital cost and are not as flexible. Trucks and shovels have low capital costs and are more flexible. But, have higher operating costs. Westcott (2004) describes the strengths and limitations of draglines/bucket-wheels vs. trucks/shovels while considering their technical applicability and financial viability.

Truck and Shovel

This method is used to establish a comparative baseline, since trucks and shovels are still being used on a commercial scale in surface mining of oil sands.

According to the Alberta Chamber of Resources (2004), surface mining has a variable recovery cost of approximately \$8.00/bbl, while capital cost is \$3 – \$4/bbl, amortized over the life of the operation. The operating costs are affected by: ore quality, energy costs, amount of overburden, material transport distances, and maintenance which occupies 50 % of the operating costs.

With current surface mining and processing technologies, 87 – 90+ % bitumen recovery is attainable. However, this high recovery is dependent on ore quality. High quality ore is considered to have 11+ % by weight of bitumen, while the remaining is composed of sand, clay and some connate water. Bitumen loss is a result of: dilution with low-quality ore, inadequate slurry conditioning, system reliability, water makeup, environmental conditions, and process instabilities.

Extracting and processing oil sands consists of many complex interconnected processes. The following figure lists the major steps involved. Only the mining stages will be briefly discussed.

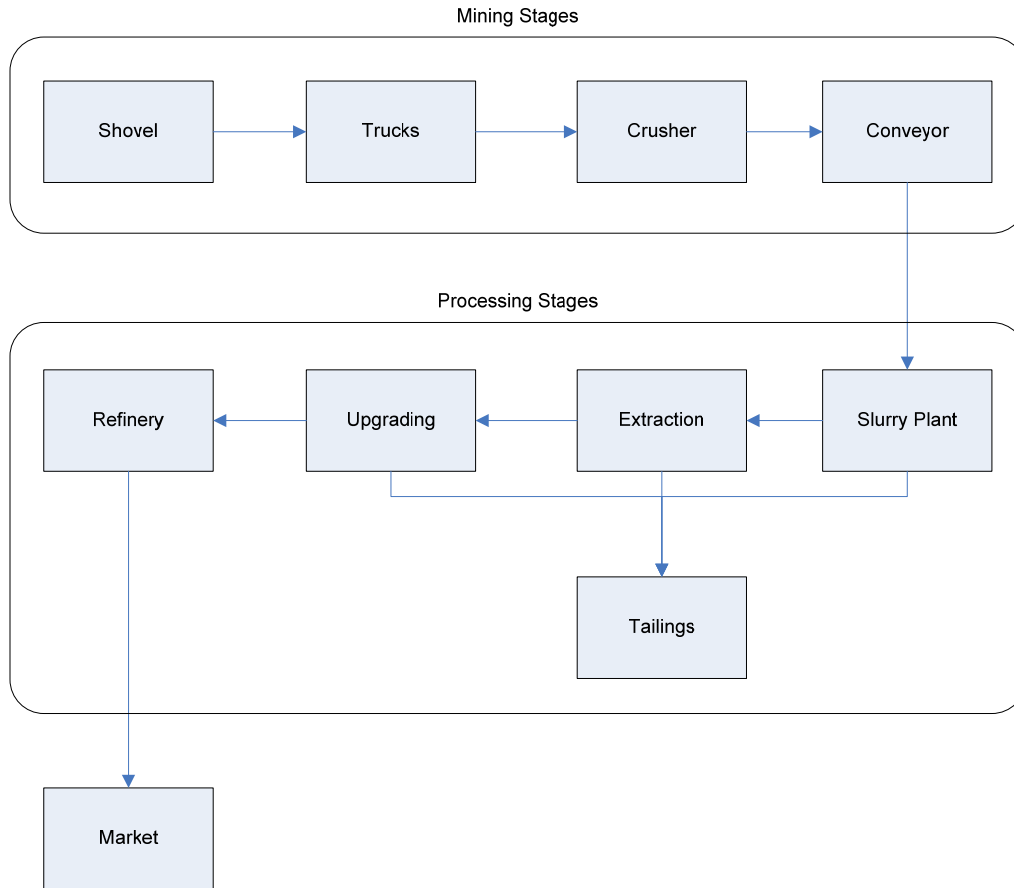

Figure 2-2 Oil sands surface mining extraction and processing stages

The mining stages consist of shovels, trucks, crushers, and conveyors. First, shovels are used to remove overburden in order to gain access to the ore body. From Joseph (2008), each shovel can cost approximately \$20 million, and the motors in these shovels can be as powerful as 19,000 hp each. Shovels can be electric or hydraulic. Following the shovels, are the trucks. A typical truck can carry a payload on the order of 345 t, and weighs in at 241,820 kg (empty) with a maximum operating weight of up to 623,690 kg. The trucks are 2 ½ stories (7.5 m) tall, and the tires have 11 ft (3.3 m) sidewalls. The trucks deliver the ore to crushers where these devices break up the ore into 12 in (0.3m) pieces. The crushed ore is then moved on a conveyor to the slurry plant. Conveyor systems are susceptible to tears associated with heavy use in severe climatic conditions.

The trucks are known to be the weakest link in an oil sands mining operation. Some areas for improvement would be more fuel-efficient engines, developing lighter trucks with more rigidity and ruggedness, and improving tire technology so that the trucks can operate more efficiently on soft ground.

2.6.5 Aqueous Extraction Mining Methods

This classification of surface mining uses water or a liquid to recover ore, and accounts for 10 % of all surface mining methods. Most aqueous extraction methods are relatively cost effective, with a 5 % relative cost compared to other mining techniques such as underground (Hartman et al., 2002).

Borehole Mining

Borehole mining is a means of hydraulically mining in situ ore through a wellbore. By injecting cold water at high velocities and high rates into the formation, a slurry is created within a confined space. As the pressure in the confined space increases, the slurry flows to the surface through the annular space between the injection string and the circulating string. As the ore is removed from the reservoir, a cavern is created, void of the ore but filled with water (Wong 1996). Figure 2-3 is a general schematic of the borehole mining process.

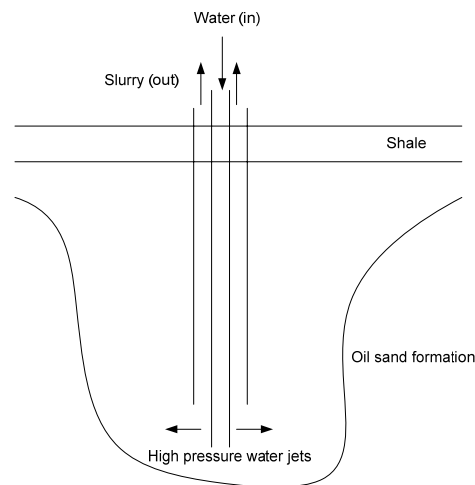

Figure 2-3 Borehole mining schematic

Borehole mining has multiple uses such as mining natural resources (uranium, iron ore, and quartz sand), oil exploration, gas and water stimulation, and underground storage construction and drainage (Hartman et al., 2002). Borehole mining is a non-entry mining method where miners do not need to go underground, and is remotely operated from the surface.

The economic viability of borehole mining is dependent on several factors such as the efficiency with which the oil sand can be mined, the ultimate ore volume that can be mined from a single well, and the rate at which oil sand can be mined.

Compared to surface mining operations, the benefits of borehole mining is that it has low capital cost and low mining cost, it has mobility and selectivity, as well as borehole mining causes minimal environmental disturbance since no overburden is removed. Finally, fragmentation and transportation are incorporated into a single system since the fragmented ore (by the water jet) is brought to the surface in the form of a slurry making it suitable for pipeline transport.

However, there are drawbacks with borehole mining. These are issues associated with recovery potential which is dependent on the size of the cavity achievable by jetting, process controllability, fines generation, water separation, slumping potential of the cavern walls, and roof stability of the mined void space.

Borehole Mining's Applicability for Oil Sand

From 1991 to 1992, Imperial Oil conducted borehole mining pilots at their Cold Lake facilities. They investigated borehole mining as an alternative to CSS to recover oil sand.

The Cold Lake borehole mining pilot testing reports reveal a number of issues that must be addressed in order for borehole mining to be successful in an oil sands application. These issues are summarized in the following points:

- Water jet cutting does not break oil sand into fine enough pieces to pass through a pump. Water jet cutting breaks off chunks of oil sand which can impede pump flow.
- Jet nozzle design is critical so that the best discharge coefficient can be achieved with the least danger of cavitation (the formation of partial vacuums in a liquid). Cavitation negatively affects equipment reliability.
- Vortex development on the outlet of the nozzle due to poor streamline coherence within the tool body is the likely cause of cavitation damage on the outer surfaces.
- The presence of solids in the discharge flow acts to sandblast the face as the flow is deflected back from the periphery of the vena contracta region.
- Turbulent flow cells in the region below the nozzles are caused by the 90° rotation of the fluid as it exits the tool.

Borehole Mining Conclusion

Borehole mining was investigated as a method to mine oil sand and is a promising technique. It is concluded that:

- There is currently no theory which adequately explains and models the cuttability of oil sands.
- Tight formations are more suited for jet cutting as opposed to formations that are highly fractured or have high permeability.
- A water-filled cavern is preferred since the water can prevent cavern subsidence. Also, a water-filled cavern will use less energy to transport the slurry as opposed to an air-filled cavern.
- To prevent the formation of bitumen droplets that are difficult to aerate and float in a conventional aqueous separation process (due to water jet cutting), one can:

- Fragment the oil sand (without any liquids), then use jets to produce a slurry. This slurry can be pumped up the drill string or be directed to a neighbouring well which acts as a collection point. In essence, creating two wells; one well for cutting and slurring, and the other well for pumping.
- Use a solvent instead of water (such as in solution mining) which is suitable for solvent extraction processes currently under development.
- Use a bitumen separation process that is not sensitive to initial droplet size or add a conditioning and coalescence step prior to separation.

Solution Mining

Solution mining is used to mine salt. Fresh water is injected into a cavern where cavities are formed as the salt and its walls dissolve. The brine (water saturated with salt) falls along the surface, and is collected by a well below. This idea led to the development of SAGD. In an oil sands application, a hydrocarbon solvent can be used in order to reduce water consumption.

Dredging

Dredging is an underwater excavation technique used for mining deposits located under shallow bodies of water. In oil sands, dredging is being developed for tailings management. Deposits located at deep depths would be excavated using ocean mining methods, while require remotely operated tooling. Although dredging is only used offshore, the material extraction and transport processes are worth examining as it may be valuable and perhaps can be applied to an oil sands mining operation. The following figure describes the categories of dredges along with an example.

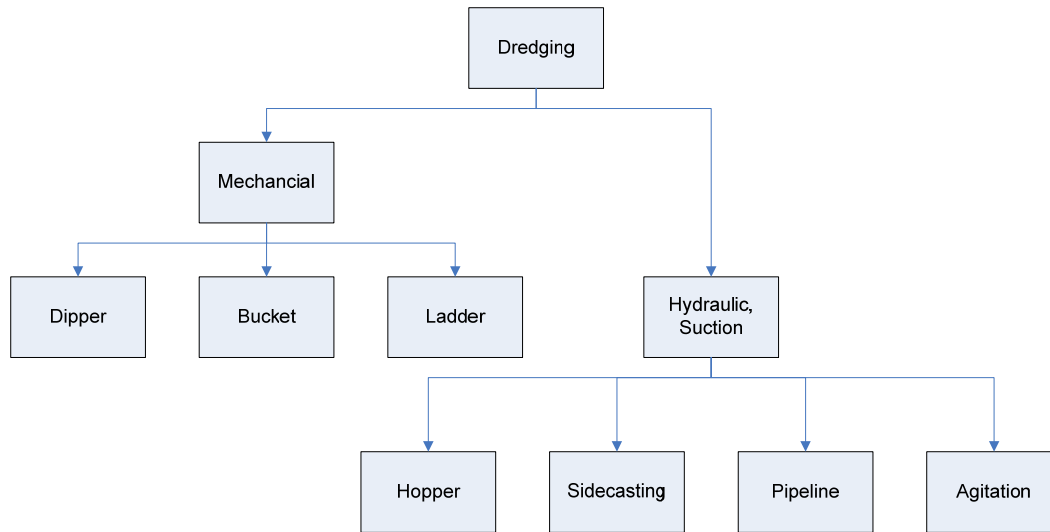

Figure 2-4 Dredging examples

Mechanical dredges excavate and transport material by mechanical means similar to land-based excavating equipment such as draglines. Hydraulic dredges transport material in a slurry using water as a medium. This is accomplished by using cutter heads or water jets to disengage and mix the material with water so that the slurry can be pumped to the surface. Hydraulic dredges are preferred over mechanical dredges due to their economic competitiveness, versatility, and efficiency. Herbich (1992) discusses in further detail.

2.6.6 Unsupported Mining Methods

Unsupported methods refer to a set of mining techniques where the formation is self-supporting and requires no extensive artificial support. Applying roof bolts and columns of timber or steel are acceptable. An unsupported mining method that has been considered for oil sands mining is room and pillar mining. This mining technique is applicable for excavating horizontal deposits such as limestone, sodium chloride, potash, coal, or any metallic deposits. Room and pillar mining involves creating passages at regular spacings and being orthogonal to each other generating square or rectangular columns for support. In an oil

sands application, room and pillar mining poses a major concern due to the unconsolidated nature of oil sand and its low strength resulting in stability issues.

2.6.7 Supported Mining Methods

Supported methods refer to a set of mining techniques which require an extensive amount of artificial support such as using backfill material. A supported mining technology that was investigated was tunnel boring machines (TBM). TBMs are used to excavate tunnels with a circular cross-section and is used as an alternative to drilling and blasting. Harman et al. (2002) reported that TBMs range in diameters from 1 – 19 m with a major benefit being its low environmental impact because a TBM does not disturb the surface while producing a smooth wall. However, there are significant drawbacks since TBMs require significant infrastructure, are expensive to construct as well as transport. Also, there is potential sterilization of parts of the ore body. Lastly, TBMs have low availability (35 – 45 %). This is due to maintenance, backup equipment, ground control, cutter replacement, etc. In an oil sands mining operation, availability needs to be 80+ %.

One of the major hurdles in using TBMs for underground mining is the large size of a TBM along with its trailing gear. Maneuverability is affected as the turning radius can be around 350 ft (106 m). Hartman et al. (2002) warned that in order to financially justify the use of a TBM, the tunnel length must be greater than 6 km. The longer the tunnel length, the more cost effective using a TBM is. For example, an 18 km length tunnel will cost \$300/m whereas a tunnel length less than 6 km can cost up to \$1500/m. It is hypothesized that TBMs can also be used in other applications, such as oil sand recovery. An example would be a patent by Drake et al. (2008) claiming how TBMs can be used for extracting oil sand. However, this is a challenge because the oil sand is a soft material with potential to clog the cutters.

2.6.8 Caving Methods

Caving methods refer to a set of mining techniques where the formation is allowed to collapse in an induced and controlled manner. An example of a caving method that was examined was longwall mining which is used to mine deposits of uniform thickness over a large horizontal distance. Longwall mining has been used for mining coal, and is an entry mining method where miners are required to go underground. Longwall mining consists of multiple shearers mounted on a series of self-advancing ceiling supports which maintains the working face while allowing the hanging wall to collapse. Longwall mining machines are 240 m long and 1.5 – 3 m high, and can extract ore at depths of 300 m (Hartman et al., 2002). This mining technique incorporates the tunneling of a series of haulage drifts in order to access production areas and to transfer ore to shaft stations. Figure 2-5 shows a shearer of a longwall mining machine in operation.



Figure 2-5 Longwall mining machine

[http://commons.wikimedia.org/wiki/File:SL500_01.jpg]

The cost for longwall mining coal is approximately \$21/t and the cost breakdown can be found in Walker (1996). In an oil sands application, longwall mining would not be applicable since having miners underground is a safety concern due to the structural stability of oil sand and regulatory issues.

2.6.9 Summary of Mining Options for Oil Sands Underground Production

This section provided an overview of current mining techniques and technologies that have potential in an oil sands mining application. Elements from these techniques and technologies were used to develop a system concept to address the fact there is currently no mining technology available to access deposits at intermediate depths. This is evident from Hartman et al. (2002) where the authors only provide possible methods to access ore at shallow depths using surface mining and methods to access ore at deep depths using underground mining.

To date, an identified challenge to overcome would be the issue of erecting and maintaining sufficient roof stability/support in order for processes such as borehole mining, room and pillar mining, TBMs, or longwall mining to be used in an oil sand application. It may be possible to develop a longwall system that can be operated remotely, with no humans underground (provided that the equipment is reliable), and to use a paste backfill to reduce the amount of subsidence. This scenario would be most appropriate when a surface mine reached a limit of overburden depth. Technology development costs, capital costs, and operating costs would have to be assessed.

Another concept is to create a pressurized cavity in which a variant of borehole mining can be done, taking care not to exceed the formation pressure. This approach will be considered further in the system concept, which will incorporate aspects of borehole mining.

2.7 Summary of Current Technology Options

This chapter examined current enhanced oil recovery methods and conventional mining techniques for their applicability as an in-situ method to fragment oil sand and transport it to the surface in the form of a slurry. Elements from these methods and techniques were used to develop a system concept for slurry

production from an oil sands deposit with an overburden covering of several hundred meters depth. This chapter described the candidate technologies and critiqued their applicability for mining oil sand as well as provided direction on technology development required in order for underground mining of oil sand to be possible.

It is concluded that in order to mine oil sand at intermediate depth, current techniques and technologies will not be feasible due to technological limitations. However, adapting and modifying current techniques and technologies will fill this knowledge gap.

In order to fill this knowledge gap, technical requirements were defined in context of current technologies and processes. Key technical requirements are to access the pay zone and mobilize the ore in the form of a slurry for transport. This will most likely be accomplished by conventional horizontal or directional drilling. Once access to the pay zone is achieved, fragmenting the oil sand via mechanical means so that the ore can be mobilized is required. This could be accomplished through the use of a modified cutting tool delivering a milling action to fragment the oil sand, and jet cutting to make the ore amenable for slurry transport similar to that of borehole mining. Any system concept would be a hybrid version of current mining techniques and technologies utilizing mostly proven technologies, and such a system concept would be integrated with existing on-site facilities thereby reducing costs.

Finally, some consideration needs to be given in assessing different technology options with a decision analysis framework to ensure that any system meets the technical requirements and has a good probability of being reliable and commercially viable. This consideration is addressed in the next chapter.

Chapter 3 System Concept

3.1 Introduction

Surface mining is used from 0 – 150 m and conventional EOR methods are used at depths from 450 – 600 m (Lipsett et al., 2007). This novel subterranean production method under consideration is designed for accessing oil sand deposits at depths that are too deep for economical surface mining and too shallow for conventional EOR methods specifically at intermediate depths of around 300 m.

One of the main benefits of this production method is that it is an underground (in-situ) method that does not require overburden removal. Compared to surface mining operations, in-situ methods are smaller in size resulting in minimal environmental footprint. From a financial perspective, in-situ methods require lower labour and allow for more possibilities to modularize components which will assist in reducing costs. Also, in-situ techniques are relatively inexpensive (provided that natural gas does not become too expensive for thermal methods). Specifically, in-situ methods require hundreds of millions of dollars compared to surface mining which are capital intensive and are on the order of billions of dollars. Finally, from a technical standpoint, in-situ techniques are not constrained by depth (although they are restricted by the depositional environment).

3.2 Concept Development

Early on in the development of the system concept, it was determined that a systematic approach was required in order to optimally design a process capable

of fulfilling the design functions stated in the earlier chapters. Figure 3-1 illustrates the path from the customer needs to the system concepts.

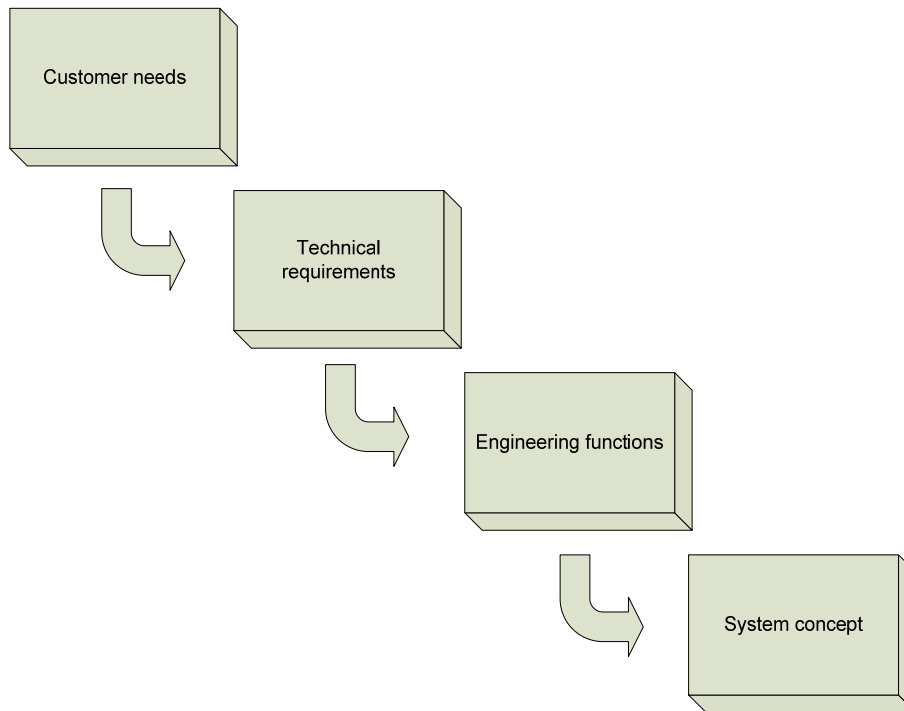

Figure 3-1 System concept development stages

The customer needs outlines the technical requirements. The technical requirements form the basis of the engineering functions. The final stage is how the engineering functions drive the definition of the system concept. To briefly recap, the customer needs were to access oil sand at a depth of 300 m. This is where no technology or process currently exists. In order to fill this knowledge gap, technical requirements were defined in context of current technologies and processes. Technical requirements were to access the pay zone and mobilize the ore in the form of a slurry for transport. This was followed by defining engineering functions that are needed to meet the requirements. Based on the technical requirements, engineering functions were to fragment the oil sand via mechanical means so that the ore can be mobilized and to use jet cutting so that a slurry can be used for transport. Finally, an optimal system concept was

developed based on the customer needs, their technical requirements, and the resulting engineering functions.

3.3 Description

3.3.1 Process Flow Diagram

Major components of the system concept are shown in Figure 3-2. Equipment that is enclosed in the rounded box is under consideration and can be integrated with existing on-site facilities thereby reducing costs. Within the rounded box, there are recycled water tanks as well as water supply tanks. These tanks supply water and/or solvent which act as a carrier/cutting fluid. High pressure pumps will pump the fluid via an injection line into the well head which will assist in the jet cutting action. Outside the rounded box, a return line from the well head will transport the ore into a primary separation vessel where the material will be isolated as either backfill or tailings. Otherwise, the ore will be further processed by a deareator or a hydrocyclone. The deareator will prepare the ore for hydrotransport by removing air and other dissolved gasses. Once the ore has been deareated, the ore will then be hydrotransported to an upgrading facility located off-site. A hydrocyclone will process the ore by removing solid particles from the gas stream so that the ore will be ready for the centrifuge or deareator. Reject material will be sent to the tailings pond. The centrifuge will separate the ore into lighter and heavier fractions. Lighter components such as water will be pumped into the recycled water tanks whereas heavier components such as fines will be sent to the tailings pond to settle. The operating site will also include power distribution from an electrical tie-in. A storage building will house spare parts and consumables. The control station will operate and monitor the entire process. A field office is where staff and operating personnel conduct administrative tasks. Finally, a crew trailer will provide a location for operators to rest.

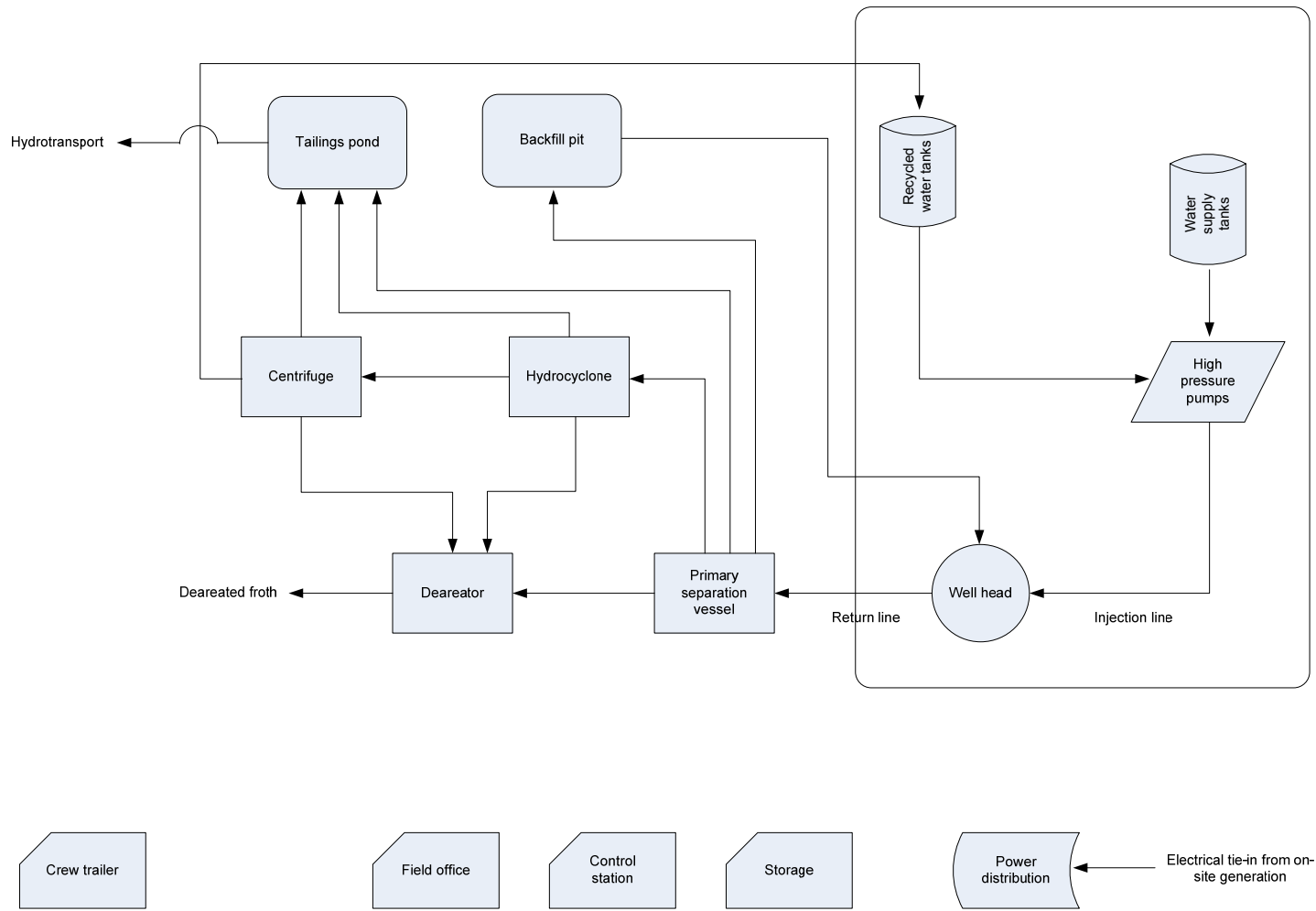

Figure 3-2 Process flow diagram

The system concept will use hydrotransport technology for material movement. The first hydrotransport line will move deaerated froth for further processing while a separate line will transfer tailings to a remediation facility.

3.3.2 Graphical Representation

Two variants of the system concept are possible. Figure 3-3 shows the vertical orientation while the horizontal version is illustrated in Figure 3-4.

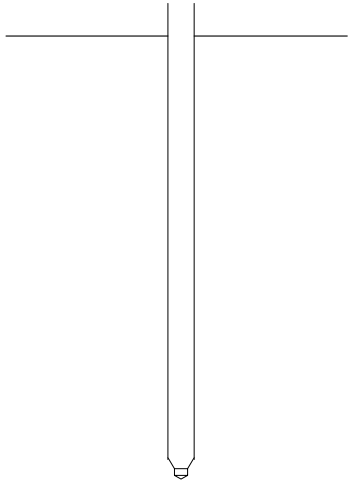

Figure 3-3 Vertical configuration

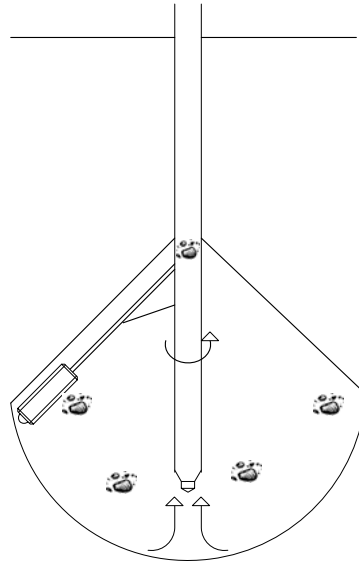

Figure 3-4 Vertical configuration with tooling deployed

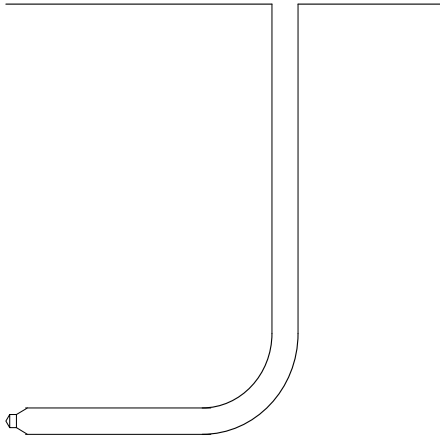

Figure 3-5 Horizontal configuration

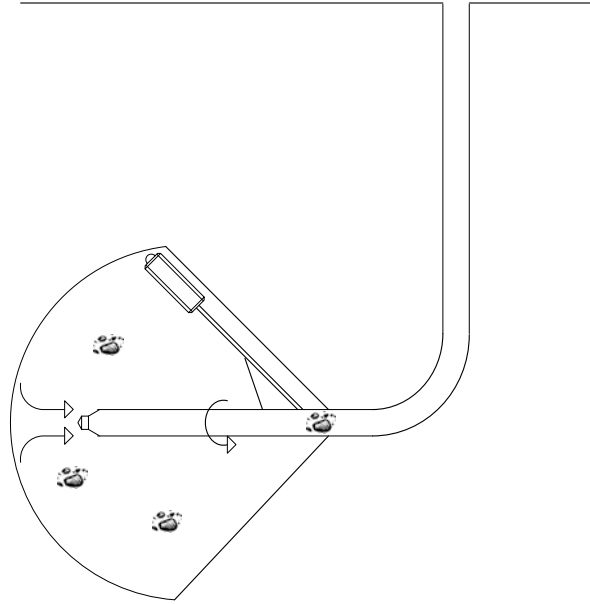

Figure 3-6 Horizontal configuration with tooling deployed

Selecting which configuration will be dependent on the geological framework of the reservoir. These include, but are not limited to, stratigraphy, mineralogy, sedimentology, and diagenesis of the formation. Stratigraphy is the layering of the strata which will affect the configuration of the system concept. Mineralogy is the composition and properties of the minerals which will have an impact on the reliability of the cutter such as tooth wear. Sedimentology is related to sand, mud, silt, and clay which will influence slurry transport. Diagenesis is the chemical and physical change of a deposit which will affect the type of carrier fluid that is required. Therefore, proper reservoir characterization will be critical to the recovery success.

Figure 3-7 shows the entire system concept in the horizontal configuration. Please note the figure is not drawn to scale as it is meant for illustrative purposes only.

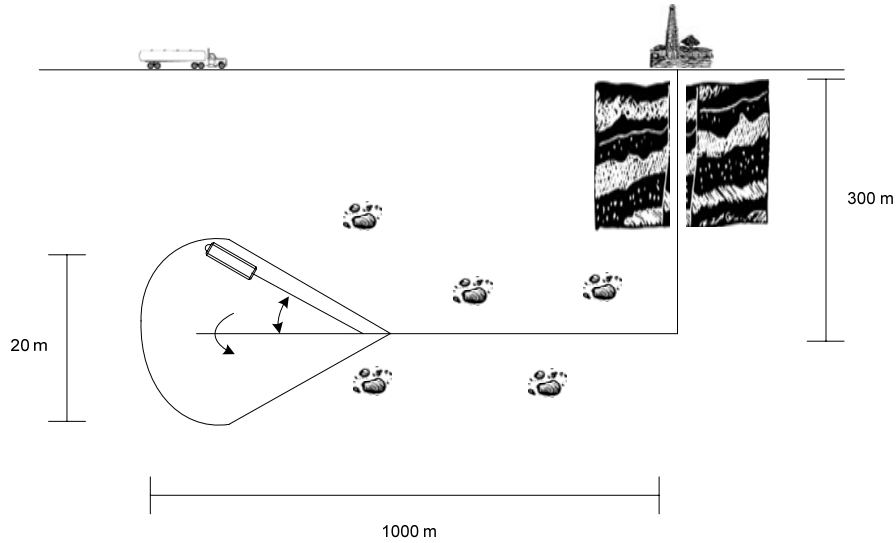

Figure 3-7 Graphical representation

The horizontal variant is suggested in order to maximize pay zone recovery and will be the subject of discussion in this thesis.

Figure 3-8 is a model of the proposed articulated tooling in its closed configuration. This position will be maintained when conventional horizontal drilling is in progress. The tooling will be deployed once the tooling has reached the pay zone



Figure 3-8 CAD model of the cutting tool in its closed position

Figure 3-9 is a rendering of the articulated fragmentation tooling in its operating position. In this mode, a mined cavity will slowly be formed as the milling head opens while the tool continues to rotate.



Figure 3-9 CAD model of the cutting tool in its operating position

3.3.3 Operating Stages

The first step of the production method is to use conventional drilling to reach the required depth of the deposit. This could either be vertical or horizontal drilling. In order to reduce rig time, a fragmenting tool integrated into the drill string would be required. The design of this fragmenting tool is beyond the scope of this thesis and will be the subject of future work.

Once drilling has been completed, the next phase is to deploy the customized articulated fragmentation tool. This tool will provide controlled cutting of the material that is amiable for slurry transport. The drill string continues to rotate as the tool is extending. This will consume the casing and gradually create a cavity in the shape of a cylinder. Similar to current drilling techniques, the proposed fragmentation tool will be remotely operated from the surface via a central control centre eliminating the risks associated with underground mining.

Jet cutting will occur simultaneously. This phase will involve the injection of a fluid such as water or a solvent. As water consumption is a growing concern with current oil sand extraction methods, non-aqueous extraction methods are in

development. A solvent could be used instead of water for the slurry. It should be noted that as the chamber is flooded with a fluid, pressurization will occur which will act to reduce the stress on the walls and ceiling of the chamber.

The cylindrical cavity is created by milling or milling in combination with jet cutting, thereby creating a slurry. A progressing cavity pump (PCP) is used to move the slurry to the surface. Progressing cavity pumps are the preferred method for carrying viscous, sand-containing fluids. PCPs use a helical rotor to lift the material.

Once the reservoir has been completely excavated, the cavity will be backfilled with material that was removed, including the fine tailings produced from the separation process. The fine solids will have to be treated to reduce the fluid volume and improve the strength, possibly by centrifugation and addition of a coagulant or flocculant. Backfill will reduce the requirement for surface tailings storage facilities, and will reduce the possibility of surface subsidence.

Backfilling will begin immediately after the cavity has been mined. This is to safeguard against premature collapse of the cavern. Backfill will enter the cavern via an injection line which will rotate to ensure material is distributed evenly.

The injection line will slowly retract to the surface as it is rotating so that the line will not be obstructed with material.

Other wells may be drilled depending on the site. This will allow the entire pay zone to be accessed without the need to further disturb other areas except for road and utility access to the drilling and tooling pads. Otherwise, reclamation efforts should commence in order to restore the disturbed land to its natural state and preparations should be made to re-introduce wildlife into the area.

3.4 Technical and Economic Assessment

3.4.1 Introduction

Solely conducting lab-scale tests will not be sufficient in determining the viability of the system concept. The tests will support the fragmentation portion of proposed idea. Therefore, a technical and economic assessment of the production method was performed using specifications from current technologies which undoubtedly change with new product development. The bases for all assumptions were from reviewing relevant oilfield literature and from discussions with representatives from Imperial Oil (B. Speirs, personal communication, November 17, 2009) and KUDU Industries (T. Grace, personal communication, December 3, 2009).

3.4.2 General Assumptions

The following general assumptions apply to this assessment:

- A field pilot is considered.
- The field pilot will be constructed on an existing site.
- The field pilot consists of one well.
- Electrical tie-in will be from on-site generation.
- A hydrotransport line will move deaerated froth for further processing.
- Another hydrotransport line will move tailings to a remediation facility.

Specific assumptions are introduced as required in their respective sections.

3.4.3 Recovery

Assuming a cylindrical cavity with a horizontal length of 1000 m and a radius of 10 m, gross recovery is calculated by:

$$V = \pi r^2 h = \pi(10)^2 1000 = 314,159 \text{ m}^3 / \text{well}$$

Assuming 75 % of reservoir material can be removed, net recovery = 235,619 m³/well.

3.4.4 Estimated Bitumen Production

Assumptions

- Bitumen saturation is 12 wt%
- Density of oil sand, $\rho_{oil\ sand} = 2100\text{ kg/m}^3$
- Density of bitumen, $\rho_{bitumen} = 960\text{ kg/m}^3$
- Density of slurry, $\rho_{slurry} = 1.65\text{ t/m}^3$
- Specific gravity of oil sand, $SG_{oil\ sand} = 2.1$

Net recovery was calculated to be 235,619 m³/well.

The mass of oil sand that can be recovered from one well is:

$$v_{ore} \times \rho_{oil\ sand} = m_{oil\ sand}$$

$$235,619\text{ m}^3 \left(\frac{2100\text{ kg}}{1\text{ m}^3} \right) = 494,799,900\text{ kg} \left(\frac{1\text{ t}}{1000\text{ kg}} \right) = 494,800\text{ t}$$

The volume of slurry produced from one well is dependent on the volume of water injected into the well. Assuming a 1:1 ratio (1 m³ of ore to 1 m³ of water), the volume of water to be injected into one well will be 235,619 m³. Therefore, the volume of slurry is:

$$v_{slurry} = v_{oil\ sand} + v_{water}$$

$$= 235,619 + 235,619$$

$$= 471,238\text{ m}^3$$

From KUDU Industries, the highest flow rate their PCP can achieve is 1000 m³/day (T. Grace, personal communication, December 3, 2009). Therefore, the time to remove the slurry from one well is:

$$471,238 \text{ m}^3 \left(\frac{1 \text{ day}}{1000 \text{ m}^3} \right) = 471 \text{ days}$$

Considering bitumen saturation, bitumen production is:

$$\begin{aligned} \text{wt}\% &= \frac{\text{bitumen}}{\text{reservoir}} \\ 0.12 &= \frac{\text{bitumen}}{235,619 \text{ m}^3} \\ \text{bitumen} &= 28,274 \text{ m}^3 / \text{well} \end{aligned}$$

Converting bitumen production:

$$28,274 \frac{\text{m}^3}{\text{well}} \left(\frac{6.2 \text{ bbl}}{1 \text{ m}^3} \right) \left(\frac{1 \text{ well}}{471 \text{ days}} \right) = 372 \frac{\text{bbl}}{\text{day}}$$

Therefore, one well will produce approximately 372 bbl/day of bitumen.

3.4.5 Common Capital

Site Preparation

The field pilot will be constructed on an existing site. However, \$50,000 is assumed to be budgeted for clearing, grading, and compacting.

Water Supply to Well

Assumptions

- Recycled water tanks and water supply tanks will be on-site.
- Two recycled water tanks will be required.
- Two water supply tanks will be required.
- Each tank costs \$150,000.
- Capacity of each tank is 1000 m³.

- Tanks are single-walled.

Table 3-1 summarizes the cost breakdown for the water supply components.

Table 3-1 Water supply components

Quantity	Item	Unit price (\$)	Net price (\$)
2	Recycled water tank	150,000	300,000
2	Water supply tank	150,000	300,000
4	Level alarms	10,000	40,000
4	Site preparation	15,000	60,000
4	Heat tracing and insulation	20,000	80,000
4	Water injection pump	50,000	200,000

Therefore, water supply to one well will cost \$980,000.

Tailings Return

A hydrotransport line will move the tailings to a remediation facility. Assuming this facility is 2 km away, the cost for tailings return will be approximately \$4 million (B. Speirs, personal communication, November 17, 2009).

Slurry Transport

Slurry will be transported via a hydrotransport line. Assuming a hydrotransport processing facility is 1 km away, the cost for slurry transport will be on the order of \$2 million (B. Speirs, personal communication, November 17, 2009).

Power

Power will be obtained via an electrical tie-in from on-site generation.

Assumptions

- Electrical tie-in hardware is \$50,000.
- Electrical tracing is \$90,000 (price adjusted from IOR's 1991 BHM pilot).

Therefore, power supply for surface facilities will cost \$140,000.

Summarizing common capital:

Site preparation	50,000
Water supply to well	980,000
Tailings return	4,000,000
Slurry transport	2,000,000
Power for surface facilities	140,000
	<hr/>
	\$7,030,140

3.4.6 Per Well Capital

Assumptions

- 16 in diameter wellbore.
- Measured depth of 1300 m (from Figure 3-7).

Drilling and Cementing

Assuming it costs \$2 million to drill and cement a 16 in diameter hole with a horizontal of 1000 m (B. Speirs, personal communication, November 17, 2009).

This is equivalent to $\frac{\$2,000,000}{1000\text{ m}} = \$2000/m$. Therefore, the cost to drill and

cement at a measured depth of 1300 m will be \$2.6 million.

Casing

Assumptions

- 16 in diameter steel.

From Sogiant Oilfield Equipment, a steel $8\frac{5}{8}$ in diameter casing costs \$35.20/m.

The following equation is applicable for pumps and vessels. However, it will still be used for the purpose of obtaining an estimate in pipe costs.

$$price_{new} = price_{old} \left(\frac{size_{new}}{size_{old}} \right)^{0.6}$$

Adjusting by weight, the 0.6 exponent is removed (B. Speirs, personal communication, November 17, 2009). Therefore, the cost for a 16 in diameter steel casing is:

$$price_{new} = price_{old} \left(\frac{size_{new}}{size_{old}} \right) = 35.20 \left(\frac{16}{8\frac{5}{8}} \right) = \$65.30 / m$$

Table 3-2 Casing specifications

Diameter (in)	Unit weight (lb/ft)	Wall thickness (in)
$8\frac{5}{8}$	36	0.400
16	78	0.500

The unit weight ratio is $\frac{78}{36} = 2.2$. Adjusting for the unit weight of the pipes, $\$65.30/m \times 2.2 = \$144/m$. Therefore, at measured depth, the casing will cost $1300 \text{ m} \times \$144/m = \$186,758$.

Tubing

Assumptions

- From Rig Planet, assume cost of steel is \$10/ft.
- 3 km (9843 ft) is needed for water injection, slurry export, and electrical cable protection.

Therefore, tubing will cost $9843 \text{ ft} \times \$10/\text{ft} = \$98,430$.

Downhole Tools

Assumptions

- Articulated tool string mechanism = \$200,000.
- Motor = \$50,000.
- Fragmenting tool = \$200,000.
- Pump = \$50,000.
- Well head top drive = \$100,000.

Therefore, the cost for downhole tools is \$600,000.

Service Rig

Assumptions

- 7 days are required for installation. Activity breakdown is as follows:
 - Mobilizing = 1 day
 - 3 tubing installs = 3 days
 - Tool install = 1 day
 - Pump install = 1 day
 - Demobilizing = 1 day
- Rig costs \$25,000/day

Therefore, a service rig will cost $\$25,000/\text{day} \times 7 \text{ days} = \$175,000$.

Pump

Assumptions

- Progressing cavity pump
- From KUDU Industries (T. Grace, personal communication, December 3, 2009), the operational life of their PCPs varying considerably. Operational life can be from a few weeks to a few years. The main factors are the amount of sand/water in the slurry and the field conditions. Therefore, assume a 1 year operational life.
- Maximum flow rate of $1000 \text{ m}^3/\text{day}$ at 500 rpm
- Unit cost = \$100,000

- Cost to install = \$25,000
- Powered by a 1 in rod-string connected to a rotor via a hydraulically-actuated drive head
- Pump OD with collars = 5.43 in
- Single helix rotor

Therefore, the pump is estimated at \$125,000.

Summarizing per well capital:

Drilling and cementing	2,600,000
Casing	186,758
Tubing	98,430
Downhole tools	600,000
Service rig	175,000
PCP	125,000
	\$3,785,188

3.4.7 Capital Expenditures

Common capital	7,030,140
Per well capital	3,785,188
CAPEX	\$10,815,328

At 40 % contingency \$15,141,459

3.4.8 Operating Expense

Bitumen recovery was calculated to be 35,986 m³/well.

Converting bitumen recovery:

$$35,986 \text{ m}^3 \left(\frac{6.2 \text{ bbl}}{1 \text{ m}^3} \right) = 223,113 \text{ bbl}$$

$$\text{Therefore, } \textit{cost intensity} = \frac{\textit{capital}}{\textit{production}} = \frac{\$14,556,874}{223,113 \text{ bbl}} = \$65.24 / \textit{bbl}$$

At 40 % contingency, cost intensity = \$91.34/bbl

Assumptions

- Since, this estimate is for a field pilot, a 1 year operational life is assumed.
- Surface lines will have a lifespan of 1 year.
- 3 tubing changes during the operational life (\$175,000 × 3 = \$525,000)
- A staff of 15 at \$75,000/yr salary = \$1,125,000
- Maintenance = \$1,300,000 (price adjusted from IOR's 1991 BHM pilot)
- Chemicals (include, but not limited to, drilling mud, dispersants, flocculants, lubricants) = \$2,100,000 (price adjusted from IOR's 1991 BHM pilot)

Therefore, operating expense = \$5,050,500.

$$\text{Alternatively, } \textit{OPEX} = \frac{\$5,050,500}{223,113 \text{ bbl}} = \$22.64 / \textit{bbl}$$

At 40 % contingency, OPEX = \$31.70/bbl

3.4.9 Summary

Recovery:	Gross	314,159 m ³ /well
	Net	235,619 m ³ /well

Estimated bitumen production: 372 bbl/day

Common capital:	Site preparation	50,000
	Water supply to well	980,000
	Tailings return	4,000,000
	Slurry transport	2,000,000
	Power for surface facilities	140,000
		<hr/>

Per well capital:	Drilling and cementing	2,600,000
	Casing	186,758
	Tubing	98,430
	Downhole tools	600,000
	Service rig	175,000
	PCP	125,000
		<hr/>

CAPEX:	Common capital	7,030,140
	Per well capital	3,785,188
	CAPEX	<hr/>

At 40 % contingency \$15,141,459

OPEX: \$23 to 32/bbl

It should be noted that commodity prices, interest rates, exchange rates, and general economic conditions will affect this estimate. Finally, costs will naturally decrease in transitioning from a development stage to a commercial operation. This is primarily due to economies of scale. Also, as lessons are learned, fewer people per well will be required, equipment development costs will eventually be eliminated, re-using equipment for multiple wells, and access to common infrastructure will aid in diminishing costs. On the contrary, other costs will inevitably be incurred. These may include but are not limited to tailings backfill equipment and process costs (cost assigned to a process based on the cost of the activities that compose the process).

3.5 Other Technical Considerations

Other technical considerations were investigated. These include, but are not limited to the following:

3.5.1 Wear Damage

Equipment operating in any industrial environment is subjected to wear. In an oil sands environment, wear damage is of great concern. This is because wear can have devastating effects on equipment reliability. Poor equipment reliability will eventually lead to downtime, thereby resulting in loss production. From Joseph (2008), wear attack is also the culprit for increased maintenance costs.

Syncrude's annual budget for maintaining and repairing equipment is greater than \$450 million. Wear damage is attributed to the abrasive nature of oil sand. As a result, wear-resistant materials will be required in order to maintain an acceptable level of equipment availability. Generally, tungsten carbide metal matrix composite material is recommended. This type of material is currently used for most of Syncrude's critical production applications. For the system concept, cutting teeth should be made from cast and forged martensitic steel while pump

impellers and tubular linings for slurry pipes ought to be fabricated from highly alloyed white irons.

3.5.2 Infrastructure

Major infrastructure components were introduced earlier in Figure 3-2. These components, such as the primary separation vessel, deareator, hydrocyclone, tailings pond, and hydrotransport lines are modular and can be shared with other nearby processes, thereby lowering costs.

Additional infrastructure would consist of first aid, cooking, bathing, and sewage facilities for on-site personnel. Potable water storage and treatment will be required for bathing. Sewage will be collected and trucked to a waste treatment facility.

3.5.3 Winter Operability

The system concept field pilot will be designed to operate year round especially through the winter months. Countermeasures were taken into consideration to ensure uninterrupted operations during cold climatic conditions. For example, heat tracing and insulation for the water injection tanks and piping will be used to prevent damage caused by freezing.

3.5.4 Water Requirements

It is commonly known that oil sand operations require a significant amount of water. In order to minimize water requirements, a solvent may be used. Assuming water is the fluid of choice, the water requirements is for a given cavity size can be calculated as a function of the percentage of densities.

Assumptions

- Density of oil sand, $\rho_{oil\ sand} = 2100\text{ kg/m}^3$
- Density of water, $\rho_{water} = 1000\text{ kg/m}^3$
- Density of slurry, $\rho_{slurry} = 1650\text{ kg/m}^3$

$$\begin{aligned}(1-x)\rho_{oil\ sand} + x\rho_{water} &= \rho_{slurry} \\ (1-x)2100 + x(1000) &= 1650 \\ x &= 0.41\end{aligned}$$

Therefore, in order to achieve a slurry density of 1650 kg/m^3 , 41 % of the cavity volume must be water. However, to allow for sufficient slurification, a 1:1 ratio (1 m^3 ore to 1 m^3 of water) is advised.

3.5.5 Pumping Requirements

As stated earlier, the system concept can be integrated with existing on-site facilities thereby reducing costs. With that in mind, the pumping requirements for the system concept will consist of high pressure water injection pumps for water/fluid jet cutting and a progressing cavity pump for subterranean slurry transport to the surface. Standby units are recommended to prevent downtime due to unforeseen circumstances.

3.5.6 Cavity Integrity

Cavity integrity is an important technical consideration because of the nature of how the system concept works (by creating a subterranean cavern). This approach is similar to borehole mining where researchers have noted the cavity roof and walls becoming unstable to a point where sloughing occurs. Wong (1996) emphasized that the success of the process depends on the sloughing mechanism of the oil sand. In order to prevent sloughing, the cavern's confining

pressure must be taken into consideration. Esso Resources Canada (1991) stated that a confining pressure equivalent to the hydrostatic head will be sufficient to maintain cavity integrity. As such, a liquid-filled cavern is recommended. Using any other form of cavity stabilization is not recommended as Imperial Oil Resources (1993) reported that a cavity filled with air will not produce oil sand to the surface. This was because the oil sand fell off the walls/roof in slabs plugging the slurry return line. Esso Resources Canada (1992) suggested the use of a physical protection device such as a polymer coating. However, cost was prohibitive and ensuring sufficient application of the coating was a challenge. Therefore, a cavity filled with a liquid such as water or a solvent is suggested in order to prevent subsidence and to assist in transporting the ore to the surface. Another hypothesis is to circulate a chilled fluid, whether it be water (with anti-freeze compounds) or a solvent. This may cause the oil sand to break off in chunks which would prevent oil sand from adhering to the cutting tool. Sonar logging can be used to monitor cavity integrity.

3.6 Technology Development Requirements

One area of the system concept that would require further investigation is the design of the cutter. An efficient cutter design will allow for the proper sizing of the ore into pieces that are amiable for slurry transport. Lipsett et al. (2009) mentions three possible cutter designs. The first design is a solid toothed cutter that fragments the ore causing debris to liberate in cavity. A second possibility is a toothed cutter with a hollow section underneath the teeth where cuttings are captured. A carrier fluid will then move the debris towards the PCP. Alternatively, a device similar to a hydraulic breaker may be used.

3.7 Testing

There are a number of uncertainties in the system concept. Testing is required to mitigate some of the technical uncertainties. The fragmentation aspect of the system concept was empirically investigated through lab-scale testing, which is described in the next chapters.

Chapter 4 Experimental Setup

4.1 Introduction

Although oilsands leases have been developed for over sixty years, the physical mechanisms associated with oil sand fragmentation remains an area of research. In 1992, Imperial Oil conducted oil sand jetting studies for their Athabasca borehole mining projects [38]. The pilot study did not meet performance expectations; and one of the researchers contended the critical need for oil sand cuttability tests in order to better understand the properties affecting oil sand fragmentation. Almost twenty has passed, and yet this knowledge gap still exists. Joseph (2002) echoed this lack of information by emphasizing that an increased knowledge of the behaviour of oil sands with respect to stability, fragmentation, and abrasion would enhance equipment design and provides the user with improved operational guidelines and maintenance strategies. This is the motivation for a set of lab-scale oil sand fragmentation tests, to collect oil sand fragmentation data under controlled conditions, thereby reducing the technical uncertainty of the proposed system concept..

4.2 Equipment

4.2.1 The Oil Sand Cutting Test Instrument

A refurbished TOS FNK 25A vertical end milling machine with a belt-type variable speed gear box was used to perform the experiments. This mill was equipped with a single-tooth tungsten carbide cutter with replaceable inserts from ISCAR Cutting Tools Ltd. The rotational speed of the mill was monitored using a

tachometer comprised of a Hall Effect sensor and a circular plate with indentations. A Logitech web cam was used to visually record the milling operation for archival purposes. Figure 4-1 provides a graphical representation of the instrumented mill with major components highlighted.

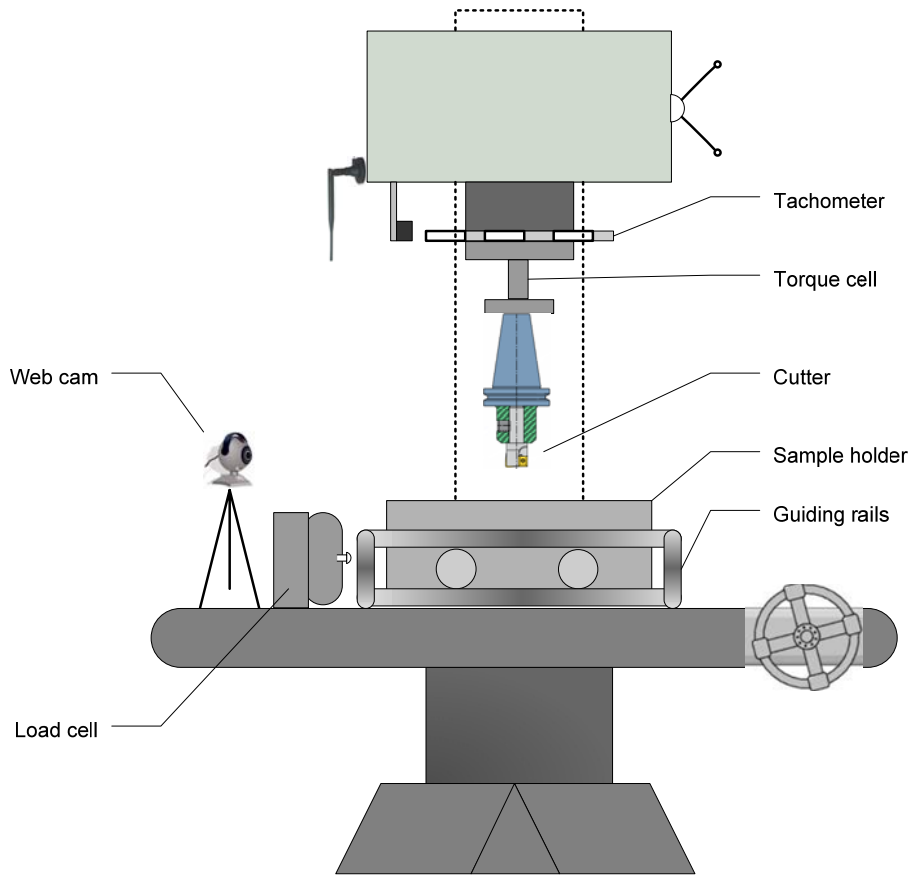

Figure 4-1 Instrumented mill

Figure 4-2 is an image of the mill. The area surrounding the mill was covered with protective plastic covering in order to assist in cleaning efforts. Most importantly, the plastic covering was put in place on the mill to prevent the oil sand debris from entering the crevices and damaging the equipment.



Figure 4-2 Photograph of the instrumented mill

4.2.2 Torque Instrumentation

A torque transducer was fabricated and strain gauges were mounted in a Wheatstone bridge configuration to measure torque while milling. A Wheatstone bridge is typically used to detect small variations in resistance that form the output of a strain gauge measurement circuit. Four strain gauges were used; two aligned in the direction of tension and the remaining two were in the direction of

compression. These strain gauges were mounted at a 45° arrangement because of the fact that when a torque is applied to a shaft, the shaft undergoes a twisting effect resulting in a stretching motion at 45° to the axis and a compression in the opposite 45° to the axis. Figure 4-3 illustrates the strain gauge configuration for the torque measurements.

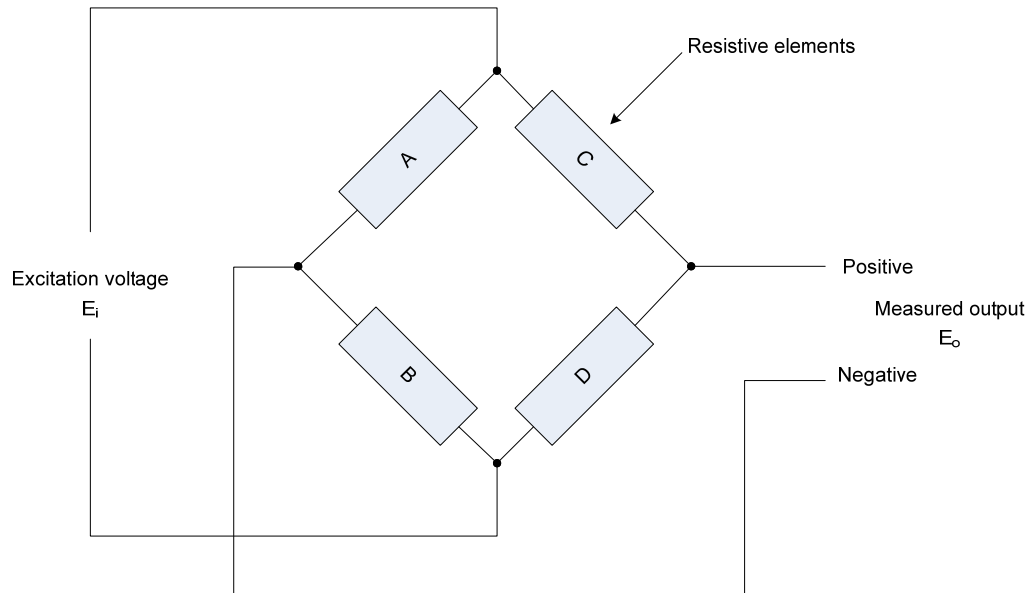

Figure 4-3 Strain gauge configuration

Measured output E_o was determined using the following equation:

$$E_o = E_i \frac{CB - AD}{(C + D)(A + B)} \quad (5.2)$$

where E_i is the excitation voltage and A, B, C, D represents resistive elements A, B, C, D respectively.

One of the challenges associated with the torque measurements was data transmission, since wires would be inappropriate due to the rotating nature of the mill's shaft. An ATI 2010B series radio telemetry system was used to permit the flow of data from the torque transducer to the computer.

The torque cell was calibrated by applying a known force and moment arm while measuring the corresponding output response using a voltmeter. This was done using a torque measuring apparatus in the Mechanical Engineering machine shop shown in Figure 4-4.

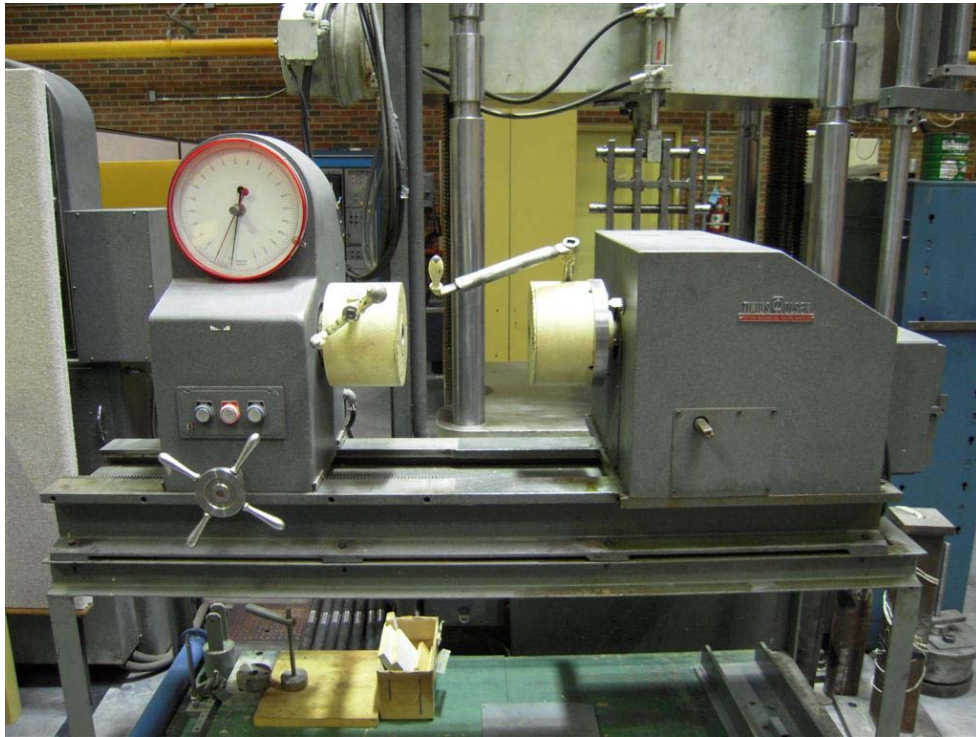

Figure 4-4 Torque measuring apparatus

Figure 4-5 illustrates the linear response of the torque cell with increasing amounts of torque. From the figure, the slope (13.8 N-m) and intercept (60.0 N-m) were used as calibration data to convert voltages into torque values.

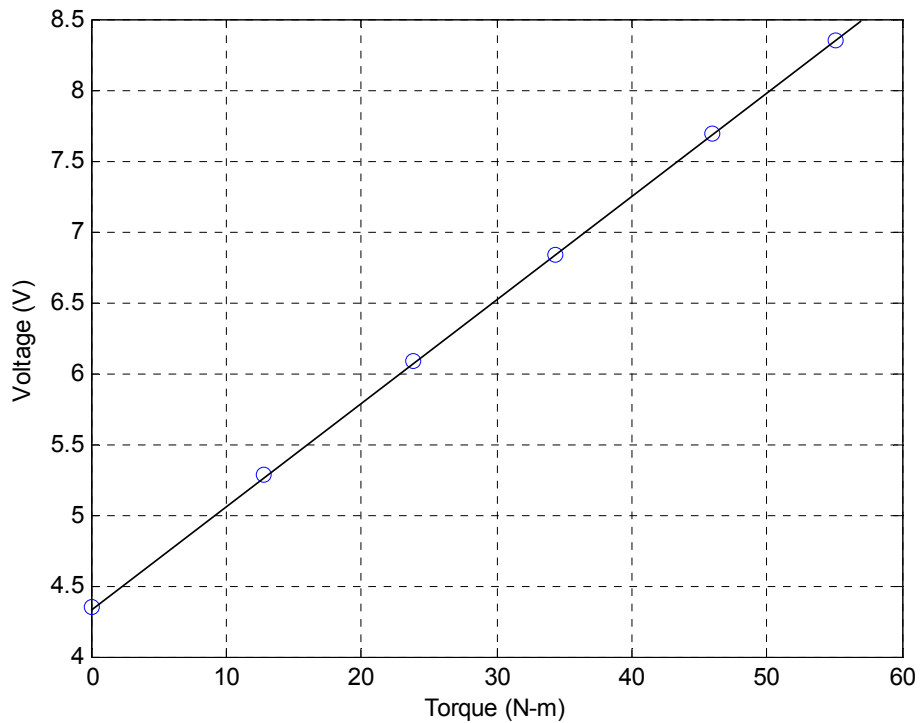

Figure 4-5 Torque cell calibration data

4.2.3 Measurement of Horizontal Force

Horizontal cutting force was measured using a Strainsert FL025U(C)-2SPKT universal flat load cell. First, an oil sand block is placed into the wheeled sample holder. As the cutter moves through the oil sand block, the cutter pushes against the load cell generating a force. Figure 4-6 illustrates the setup. The sample holder was constrained on guiding rails to reduce lateral motions.

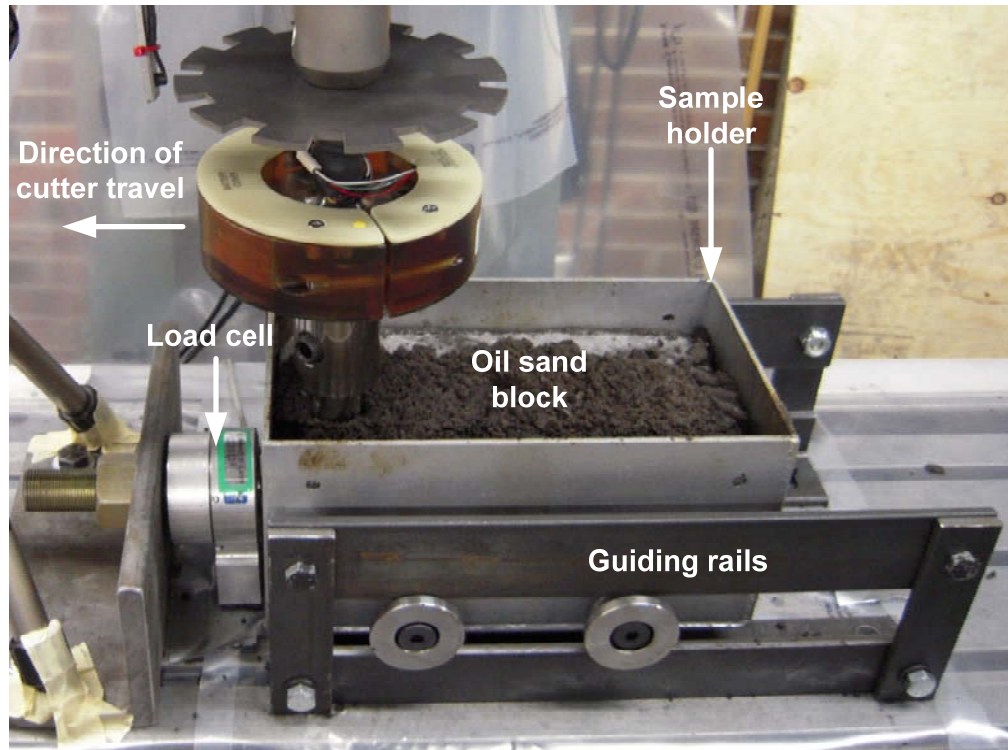

Figure 4-6 Horizontal cutting force measurement setup

The load cell was calibrated using the same Instron load frame that was used to make the oil sand blocks, by applying known forces to the load cell. From the manufacturer's data, the load cell had a 250 lbf (1112 N) limit. Using the Instron load frame, forces at 50 lbf (222 N) intervals were applied to the load cell up to its maximum capacity while recording forces' corresponding voltages using a voltmeter. Figure 4-7 shows the linearity of the load cell with increasing forces being applied. From the figure, the slope (10.3 lbf, 46 N) and intercept (95.3 lbf, 424 N) were used as calibration data to convert voltages into force readings.

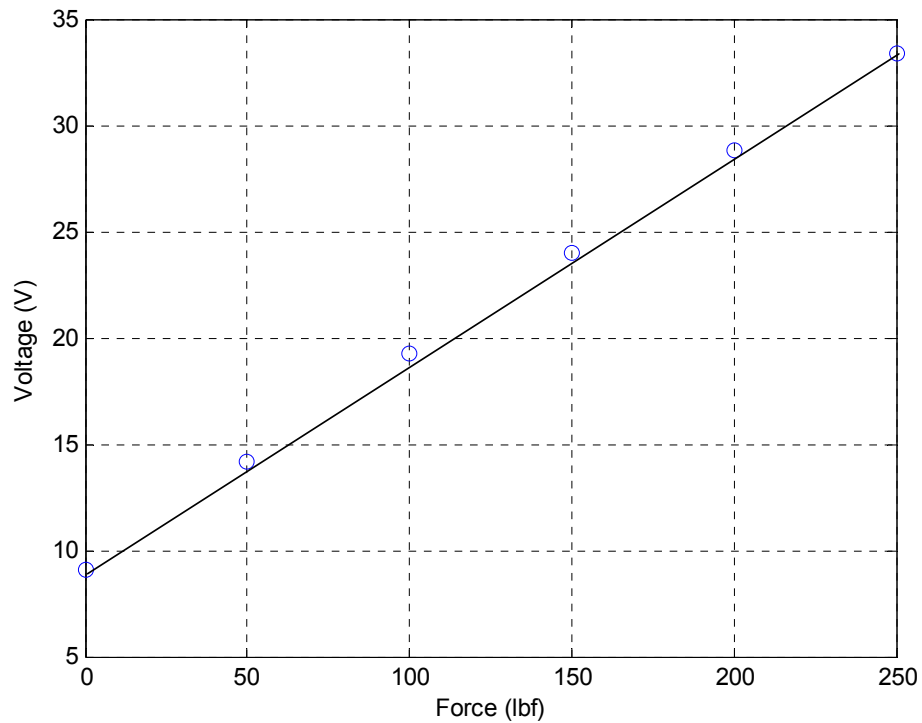

Figure 4-7 Load cell calibration data

4.2.4 Data Acquisition

National Instruments hardware and software were used for data acquisition. Hardware consisted of an eight-input bus-powered multifunction data acquisition module. Software developed in a LabWindows/CVI programming environment was used to record the data. Figure 4-8 is a data flow diagram depicting the various devices and how they were integrated together.

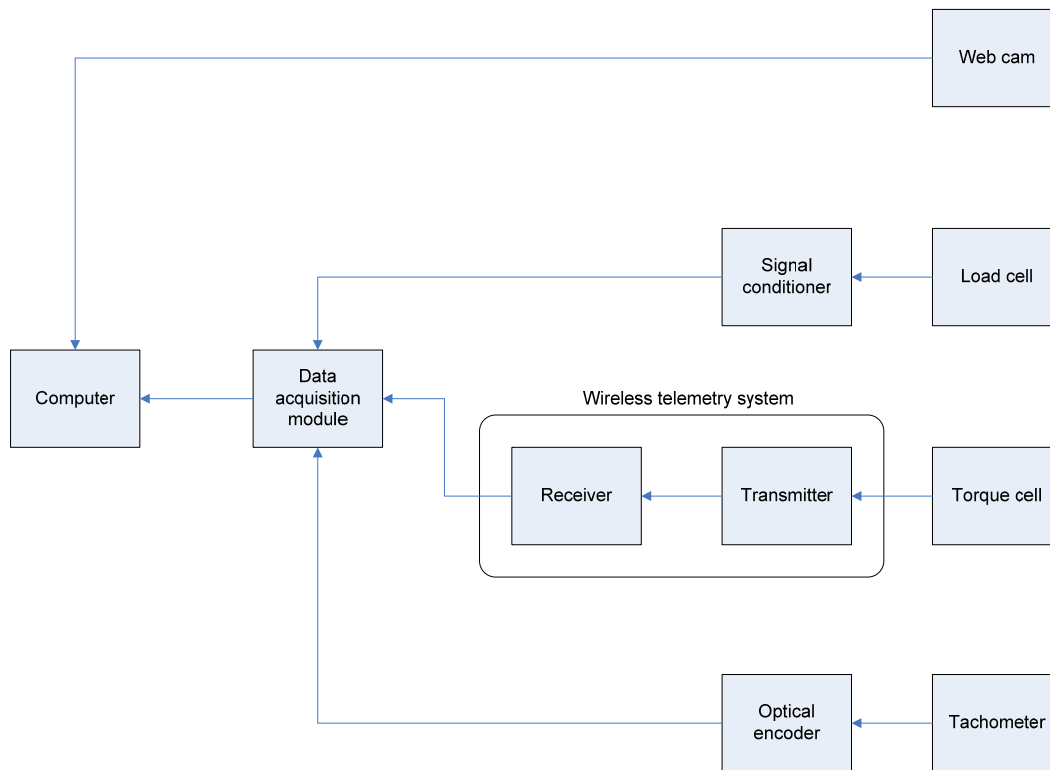

Figure 4-8 Data flow diagram

A signal conditioner amplified the output signal of the universal flat load cell to increase the signal-to-noise ratio, and provided a source of power for the load cell to function.

An alternative method in measuring torque and cutting forces in milling operations is described in Milfelner et al. (2005). In that study, the researchers utilized commercially purchased instrumentation with the goal of designing an online condition monitoring system for machining tools.

4.3 Oil Sand Introduction

According to Wong (2001), oil sand is a dense granular material with an interlocking fabric containing bitumen (soluble organic matter) and clay shales (compacted clay or mudstone), and is primarily dominated by quartz. Oil sand is a unique material. Depending on climatic conditions, the load bearing capacity of

oil sand is greatly affected. Joseph (2002) and others have observed that oil sand softens during warmer months; however, under colder seasonal conditions, the same oil sand hardens to a firm crust. Oil sand is detrimental to equipment condition. For example, Brittin et al. (1992) concluded that the abrasiveness of oil sand (due its fine and angular nature) is very damaging to high pressure positive displacement pumps. Further characteristics are described in the following sections.

4.4 Oil Sand Sampling Limitations and Techniques

From discussions with Syncrude personnel (M. Anderson, personal communication, April 6, 2009) and Imperial Oil geologists (S. Stancliffe, personal communication, March 19, 2009), it was revealed that there are various methods used for obtaining oil sand specimens. These include, but are not limited to: core sampling from an undisturbed deposit, bulk sampling by excavation, augering into an undisturbed deposit, excavation from an exposed ore face, and manual collection of samples from the ground or from stockpiles such as a lump dump. Research has indicated that there is a range of sample preparation techniques to reduce the mechanical loading on samples, to reduce gas exolution, and to reduce drying and oxidation.

Appropriate sampling of oil sand can be a challenging process, as sample disturbance caused by mechanical loading and gas release can affect the oil sand specimen structure. Kosar (1989) mentioned that the destructive release of hydrocarbon gases found in the pore fluids occurs when the confining pressures and stresses are reduced during coring or other access methods. This phenomenon results in the loss of interlocking contacts at the grain boundaries causing grain movement and rotation resulting in decreased shear strength.

Agar (1984) found getting samples from the surface will not be representative of in-situ conditions because more deeply buried oil sands are known to contain

much higher concentrations of dissolved hydrocarbon gases in the pore fluids. Therefore, conventional geotechnical methods are often inadequate for sampling oil sands. To obtain higher quality specimens, pressure coring and in-situ freezing have been done, but on a limited basis primarily due to high cost.

Dusseault (1977) stated that dissolved gas comes out of solution when confining stresses are removed rapidly resulting in an internal pressure that expands the oil sand specimens disrupting their fabric. Therefore, for the purposes of the fragmentation tests in this thesis, it was decided to obtain samples manually from an open-pit mine stockpile with frozen lumps, in which gas release has occurred slowly to minimize mechanical disturbance. However, due to logistical problems with obtaining the samples, alternative methods were investigated. These included: engineered oil sand, Ottawa silica sand, tailings sand, silica sand, and compacting unconsolidated oil sand into blocks. These are explained in the subsequent sections.

4.4.1 Engineered Oil Sand

Fong et al. (2004) prepared their own oil sand. However, it was determined that their oil sand will not be applicable for the milling tests, since their oil sand was designed for flotation performance tests, not for mechanical testing as the milling tests would require. Their model oil sand resembled loose sand coated with bitumen. It should be noted that there was insufficient amount of water for the oil sand to be a paste.

4.4.2 Ottawa Silica Sand

Ottawa sand is an ASTM (American Society for Testing and Materials) standard sand. It was investigated to act as a key component in engineering oil sand for the milling tests. Ottawa sand is uniform in size and spherically shaped. This

standard sand was considered not appropriate for the milling tests since it does not capture the particle shape nor the characteristics of oil sand. These characteristics include: angularity, grain size, roundness, grain interlock, shearing angle, grain surface rugosity, and shear-banding pattern.

4.4.3 Tailings Sand

Tailings sand - otherwise known as beach sand - was another critical component that was explored. The advantage of tailings sand is that it captures the particle shape of the oil sand, but unfortunately tailings sand does not represent all of the attributes of oil sand. Therefore, tailings sand was not considered.

4.4.4 Silica Sand

Silica sand was also investigated. Silica sand can be purchased in various particle sizes. However, similar to Ottawa sand and tailings sand, silica sand does not portray the characteristics of oil sand. Hence, silica sand was disregarded.

4.4.5 Plasticine

Plasticine mixed with grit was examined. No prior work on milling plasticine was found. However, studies by Ji et al. (2009), McClay (1976), Schopher et al. (2002), Zulauf et al. (2004), and Boutelier et al. (2008) indicate that due to the rheological properties and behavior of plasticine, ensuring sufficient grit distribution would pose a challenge, and so plasticine was not pursued as an option for physically modeling oil sand.

4.4.6 Oil Sand Blocks

After investigating the various aforementioned options and through consultations with oil sand experts, it was decided that purpose-made oil sand blocks would be necessary and will be sufficient for the milling tests.

4.5 Custom-Made Oil Sand Blocks

Oil sand was obtained from an existing oil sand operation in Fort McMurray, Alberta. The oil sand was transported and stored in an impermeable container. Due to the unique properties of oil sand, the process of manufacturing the oil sand blocks involved understanding the effects on material properties of consolidation (pressing), freezing, and storage. These issues are discussed below.

4.5.1 Consolidation

Ola (1991) conducted a geotechnical investigation on the properties and behaviour of oil sand. For his tests, he used three consolidation methods; the Standard Proctor, the Modified Proctor, and the West African standard. These methods are based on ASTM standard D698, ASTM standard D1557, and the AASHTO (American Association of State Highway and Transportation Officials) standard, respectively.

During the consolidation process of the oil sand blocks, the Standard Proctor method was followed because of the similar compactive effort that was required for the blocks. The Standard Proctor method yields a compactive effort of 600 kPa whereas the oil sand blocks required a compactive effort of 750 kPa (Wong, 1999) to be representative of in-situ conditions. Figure 4-9 shows the work area

where the oil sand blocks were made, with the press and frame shown on the right.



Figure 4-9 Photograph of oil sand block making work area

4.5.2 Freezing

Considering how the strength of oil sand is dependent on preventing gas evolution, freezing was used in an attempt to retard the destructive release of volatile hydrocarbon gases from the pore fluids, loss of water by desiccation, and chemical changes such as oxidation.

The methods and effect of freezing were taken into consideration after reviewing literature by Johnsson et al. (1995), Eigenbord (1996), and Viklander (1998). Also assessed were: ASTM standards D6035 (freezing and thawing), D2113 (sampling), and D4220 (preserving and transporting). An image of a frozen oil sand block is shown below.



Figure 4-10 A frozen oil sand block

4.5.3 Storage

One critical flaw of the research reported in Ola (1991) is that there was no attempt to control the storage conditions of his samples. This deficiency would have resulted in moisture and volatile hydrocarbons to escape. Corrective actions were taken for the construction of the oil sand blocks in this study.

After the blocks were made, a considerable amount of effort was taken to maintain the structure of the oil sand block by storing the blocks in impermeable pouches and housing them in a sub-zero climate controlled environment. Figure 4-11 shows how the oil sand blocks were kept.



Figure 4-11 Oil sand blocks stored in air-tight packing in a cold environment

4.5.4 Conclusion

Upon creating the custom-made oil sand blocks, three critical tests (shear testing, extraction testing, and porosity measurements) were undertaken to determine if the blocks' were indeed representative of oil sand found in-situ. These crucial tests would validate the blocks' mechanical strength and chemical properties.

4.6 Experimental Design

4.6.1 Introduction

A design of experiment (DOE) is a systematic approach to extract the maximum amount of information from the minimum number of trials. The purpose of a DOE is to save time and reduce costs. This involves all combinations that can be formed from the variables. A DOE testing approach was used.

4.6.2 Key Variables

The variables that were adjusted were: feed rate, rotational speed, sample state, and cutting environment. Feed rate and rotational speed were chosen due to the limitations of the mill. Sample state and cutting environment were chosen in an attempt to simulate expected field conditions as accurately as possible. Rationale and their operating ranges are discussed below:

Rotational Speed

The rotational speed of the mill can be set from 56 rpm to 4500 rpm. However, 500 rpm was determined to be the safest maximum speed the mill can run at due to observable instrumentation instability: at 500 rpm, instrumentation started to vibrate dangerously due to its centre of gravity. Therefore, rotational speeds of 200 rpm, 300 rpm, and 400 rpm were chosen to optimize the allowable operating range in the safest possible manner.

Feed Rate

The mill feed rate can be set from 1.6 in/min (0.68 mm/s) to 27.5 in/min (11.6 mm/s). Tests were conducted at all twelve possible mill feed rates. The feed rate of the mill increases in an exponential manner, as shown in Figure 4-12.

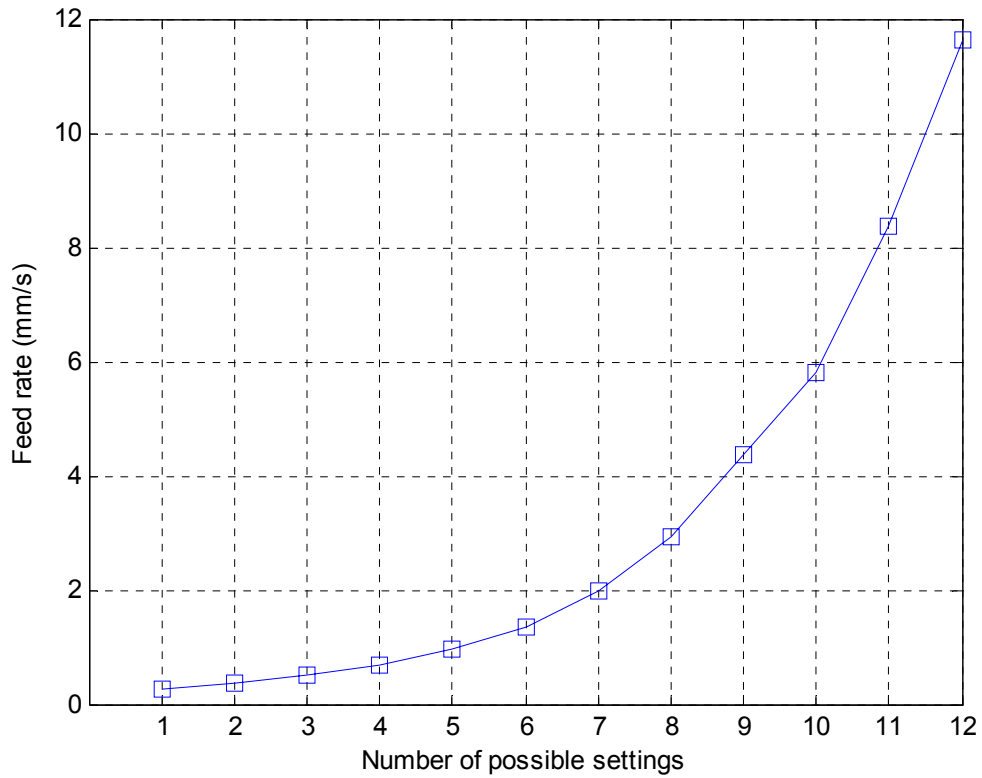

Figure 4-12 Feed rate relationship

Sample State

The purpose-made oil sand blocks were tested in thawed and frozen states in an effort to be more representative of possible in-situ conditions. From thermal imaging, the temperature of the frozen blocks was on average - 16 °C.

Cutting Environment

Tests were conducted in dry and wet states to determine how a liquid, in this case water, would behave as a lubricating/carrier/cutting fluid similar to that of borehole mining and jet cutting. Ordinary tap water at room temperature was used.

4.6.3 Measured Variables

Horizontal cutting force and torque were the measured parameters. The maximum cutting force that the load cell can measure was 250 lbf (1110 N) and the maximum torque the mill can generate was 100 N-m. Test conditions were chosen so as not to exceed these limits.

4.6.4 Controlled Variables

Tests were performed at room temperature (25 °C) under standard atmospheric pressure (101.3 kPa). A single-tooth cutter was used at a cut depth of 0.5 in (1.27 cm) to allow for sufficient removal of debris and to prevent detrimental chip overload that was encountered.

4.6.5 Chip Load

According to Kalpakjian et al. (2006), chip load is a fundamental and critical parameter in milling operations. Recommended chip loading ranges from 4 thou/tooth to 9 thou/tooth. Chip load is calculated by the following equation:

$$L = \frac{f}{R} \div N \quad (5.1)$$

where	L	=	chip load	thou/tooth
	f	=	feed rate	in/min
	R	=	rotational speed	rpm
	N	=	number of teeth	

Chip load was analytically calculated from the nominal testing conditions for the single-tooth cutter. Results are found in Table 4-1.

Table 4-1 Chip load

Feed rate (in/min)	Feed rate (mm/s)	Rotational speed (rpm)	Chip load (thou/tooth)
1.6	0.68	200	8
		300	5.3
		400	4
2.3	0.97	200	11.5
		300	7.7
		400	5.8
3.2	1.35	200	16
		300	10.7
		400	8
4.7	1.99	200	23.5
		300	15.7
		400	11.8
6.9	2.92	200	34.5
		300	23
		400	17.3
10.3	4.36	200	51.5
		300	34.3
		400	25.8
13.7	5.80	200	68.5
		300	45.7
		400	34.3
19.8	8.38	200	99
		300	66
		400	49.5
27.5	11.64	200	137.5
		300	91.7
		400	68.8

Chip load was plotted with respect to feed rate and rotational speed. Chip load behaves in an increasing linear manner with respect to feed rate as shown in Figure 4-13 where rotational speed was held constant at 400 rpm.

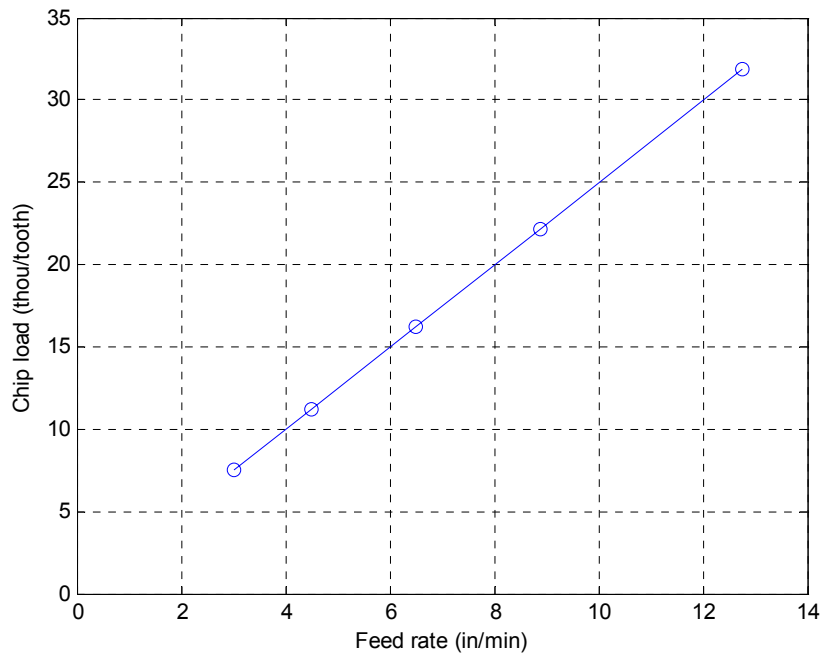

Figure 4-13 Chip load vs feed rate

Figure 4-14 illustrates the exponential decaying nature of chip load as a function of rotational speed while feed rate was kept constant at 27.5 in/min (11.6 mm/s).

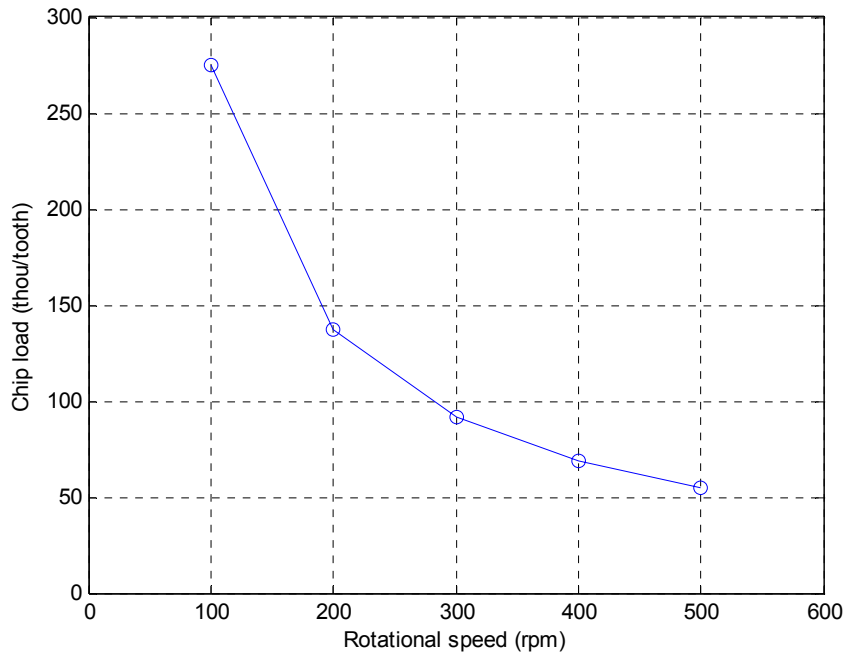

Figure 4-14 Chip load vs rotational speed

4.7 Summary

This chapter provided information on the equipment, instrumentation, and oil sand samples. The equipment consisted of a refurbished horizontal mill with instrumentation to gather force and torque data. After investigating the various options for making the oil sand samples and through consultations with oil sand experts in academia and industry, it was decided that custom-made oil sand blocks would be necessary and will be sufficient (at this stage) for the fragmentation tests. Upon creating the custom-made oil sand blocks, three critical tests (shear testing, the Dean-Stark extraction test, and porosity measurements) were undertaken to determine if the blocks' were indeed representative of oil sand found in-situ. These crucial tests would validate the blocks' mechanical strength and chemical properties.

Chapter 5 Results and Discussion

5.1 Introduction

This chapter discusses the empirical results obtained from the shear tests, extraction tests, porosity measurements, scanning electron microscopy, thermal imaging, digital microscopy, and fragmentation tests. Adhering to a design of experiment approach, multiple trials randomized over a varying time period was used.

In an attempt to simulate expected field conditions as accurately as possible, tests were performed under various cutting conditions that may be encountered in real-world operating conditions. Also, Tarng et al. (1995) reported that cutting forces are strongly correlated with cutting conditions. Tests were conducted under three states; dry, wet, and frozen. Frozen tests were performed for the sake of comparison and to gather supplementary data. Frozen tests ceased at a feed rate of 4.7 in/min (1.99 mm/s) and 400 rpm due to previous experience with detrimental damage to equipment.

5.2 Shear Testing

Shear testing is common in civil engineering for the purposes of slope stability and foundation support. Consolidated undrained shear tests were conducted on the purpose-made oil sand blocks. These tests were performed according to ASTM D3080 shear testing standard.

Table 5-1 lists the empirically obtained shear testing parameters. The high cohesion is due to fines content and bitumen content. The internal friction angle is similar to the result obtained by Wong (1991). Ola (1991) had a lower internal friction angle due to a higher percentage of bitumen. Higher internal friction angle is representative of high shear strength.

Table 5-1 Shear testing parameters

	Obtained result	Ola (1991)	Wong (1991)	Wong (1996)
Cohesion, c (kPa)	17.4	15	not applicable	5
Internal friction angle, ϕ ($^{\circ}$)	28	19	30	not applicable

Shear strength is the maximum strength of a material at which point deformation or yielding occurs due to an applied stress. The shear strength of the purpose-made oil sand blocks was found to be 950 kPa whereas the shear strength obtained by Dusseault (1978) was 2062 kPa. The relatively low shear strength can be attributed to the fact that the oil sand particles did not interlock adequately enough. Lower shear strength is attributed to the loss of the interlocking contacts at the grain boundaries of the oil sand particles which resulted in grain movement and sliding. Figure 5-1 illustrates the relationship between shear stress and normal stress.

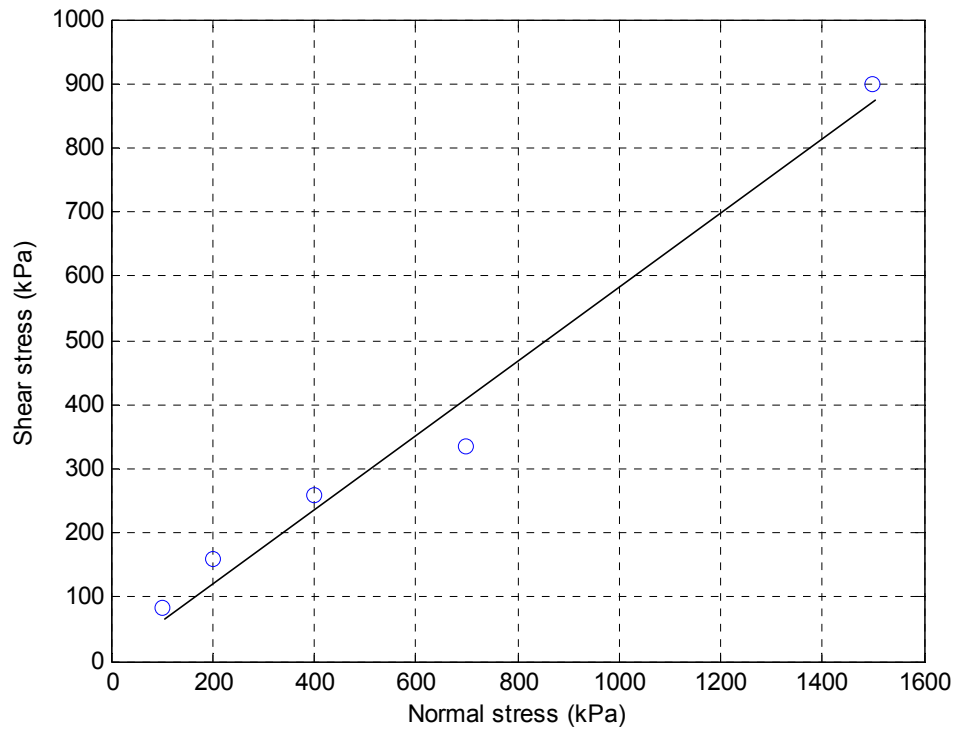

Figure 5-1 Direct shear strength

5.3 Dean-Stark Extraction Test

The Dean-Stark extraction test is commonly used in petroleum engineering for determining fluid saturation (water content, bitumen content, and solids content). Syncrude also used this method as well as Nuclear Magnetic Resonance (NMR) spectroscopy for core analysis in their labs. NMR spectroscopy was not used because of time constraints. The Dean-Stark was used to analyze the fluid saturation of the custom-made oil sand blocks. Toluene was the solvent of choice and the results are found in Table 5-2. The results are indicative of a high-quality oil sand.

Table 5-2 Extraction testing result

	Percentage (%)
Water content	4.1
Bitumen content	11.4
Solids content	84.5

5.4 Porosity Measurements

The porosity of oil sand plays a crucial role in the efficient recovery of bitumen. This is due to the fact that porosity can pose a restriction on the amount of diluent that can penetrate the pore spaces of the oil sand. Alternatively, the more porous the oil sand is, the better it is at accepting a diluent. Therefore, oil sand saturated with a diluent will cause bitumen to liberate from the oil sand matrix more easily in gravity separation cells. A diluent, such as condensate or tripolyphosphate, acts to lower the viscosity of bitumen and impacts the penetration time required for successful bitumen recovery.

Porosity measurements on the purpose-made oil sand blocks were performed and yielded an average porosity of 16 %. This result is within the lower range of the porosities obtained by Hupka et al. (2004) where they reported porosities of 15 – 40 %.

5.5 Scanning Electron Microscopy

Scanning electron microscopy (SEM) was used by Wong (1999) to visualize the internal microstructural features of oil sand. These features included: the interlocking structure, shear banding patterns, grain particle arrangement, and porosity spatial distribution of an oil sand matrix. SEM tests were performed on the purpose-made oil sand blocks for such purposes. A field-emission scanning electron microscope with back-scattering was used.

The following images reveal the fine and angular nature of oil sand giving it its abrasive characteristics. The shear strength of oil sand is the result of its interlocking structure and can also be seen from the images along with grain particle orientation and porosity spatial distribution.

Figure 5-2 and Figure 5-3 shows the interlocking nature of the oil sand particles at two magnifications. From the two images, the compactness of oil sand blocks can be readily seen.

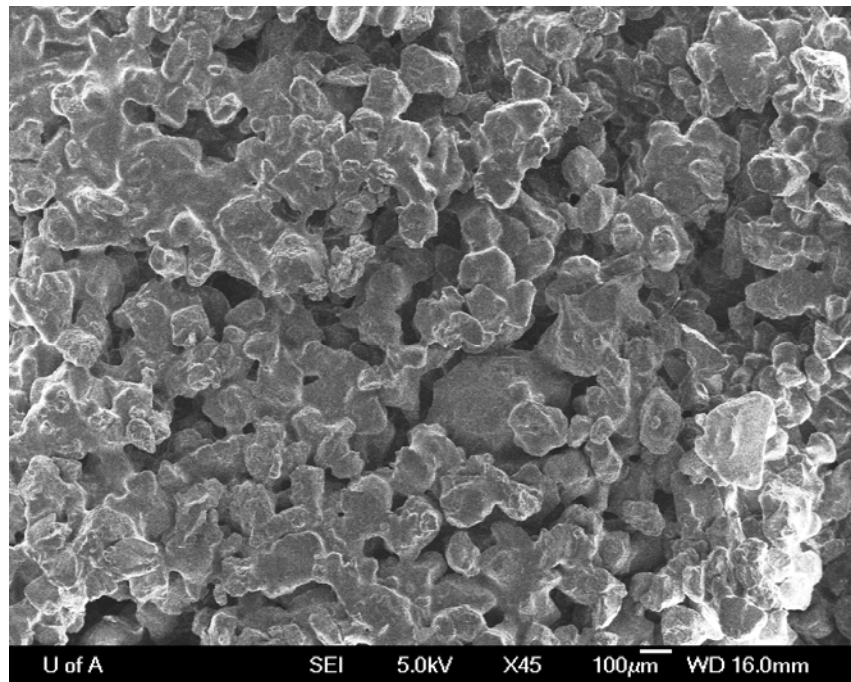

Figure 5-2 SEM image of oil sand at 45x magnification

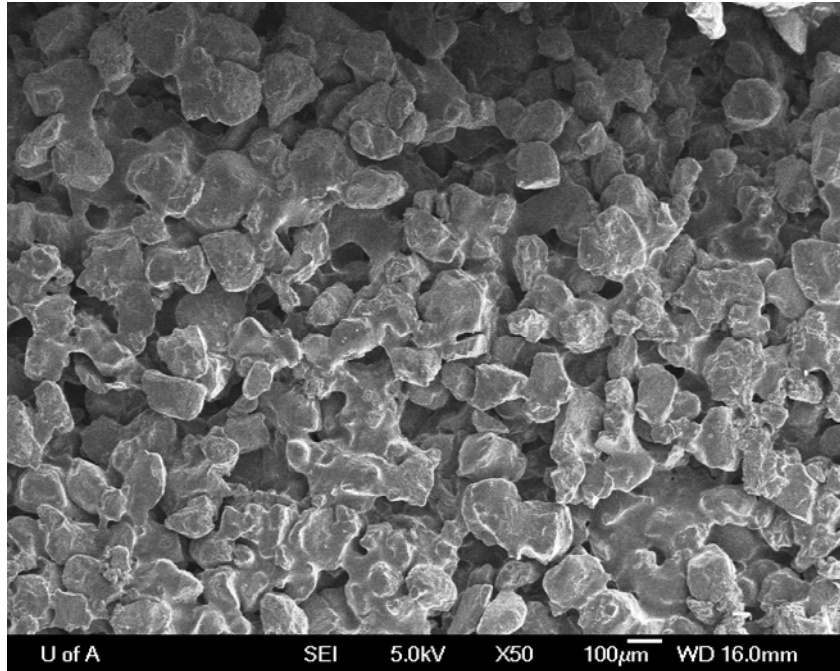

Figure 5-3 SEM image of oil sand at 50x magnification

Figure 5-4 to Figure 5-6 illustrates the angularity of an oil sand particle at increasing magnifications from 500 times to 2000 times.

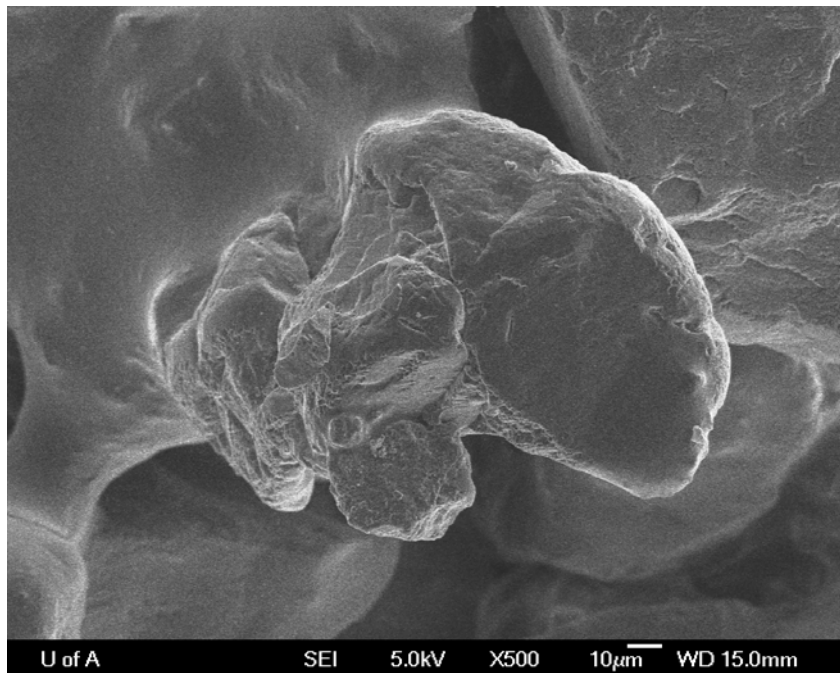

Figure 5-4 SEM image of oil sand at 500x magnification

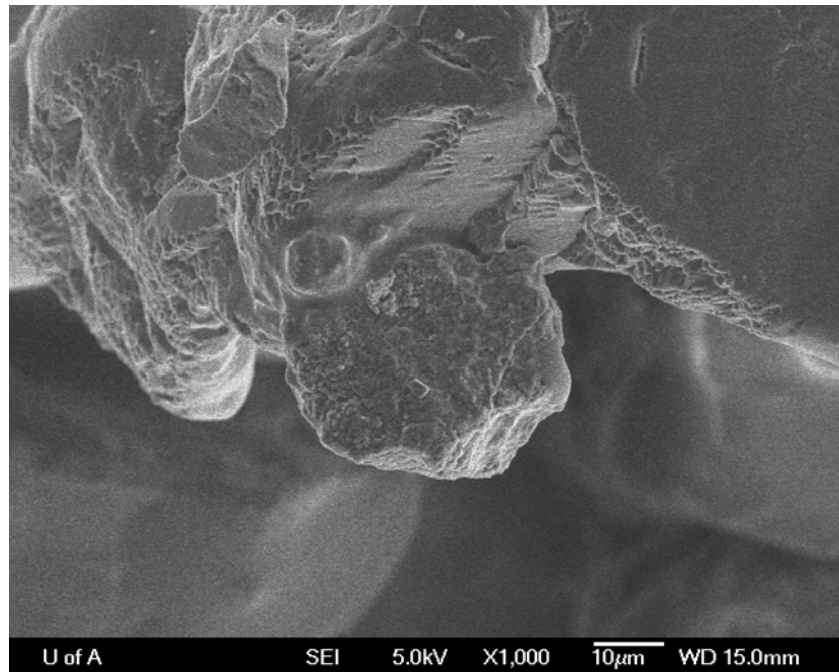

Figure 5-5 SEM image of oil sand at 1000x magnification

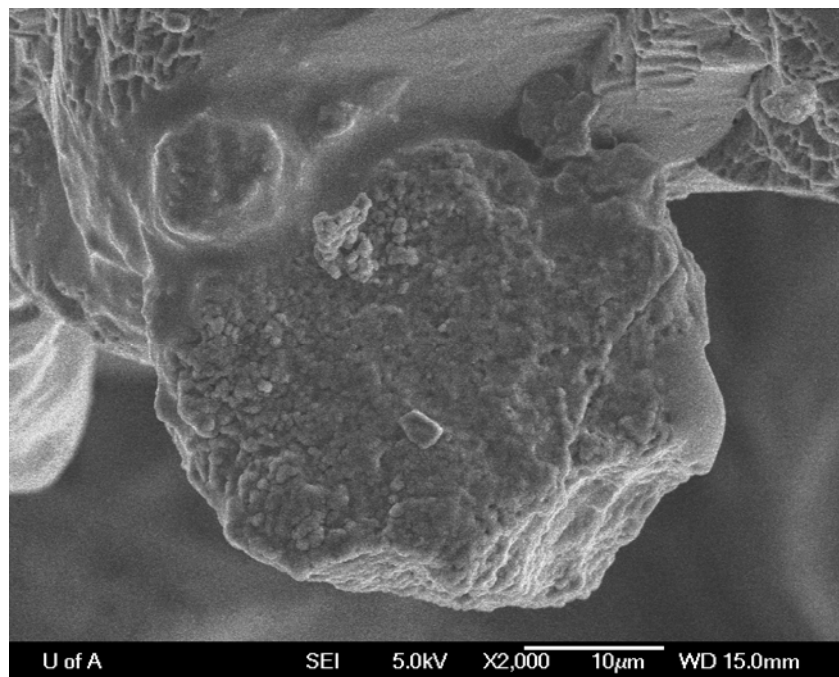

Figure 5-6 SEM image of oil sand at 2000x magnification

From visual observations, the oil sand blocks appear to be similar to what was obtained by Wong (1999). Images were not analyzed in detail, as SEM image

analysis of oil sand is beyond the scope of this thesis. For more information on SEM digital imaging methods, the reader is advised to refer to Ibrihim et al. (1991) and Kuo et al. (1996).

5.6 Thermal Imaging

Thermal imaging was performed in an attempt to determine temperature variation during the fragmentation process. Fragmentation tests yielded chip temperatures of approximately 25 °C while the temperature of the oil sand block was close to -16 °C. The following are images illustrating the thermal distribution during testing.

Figure 5-7 is a thermal image of an oil sand block immediately taken from cold storage and placed on a surface in room temperature.

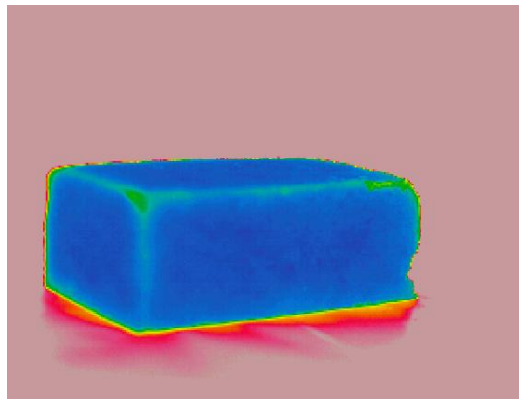

Figure 5-7 An oil sand block resting on a surface

Figure 5-8 to Figure 5-12 are thermal images depicted the thermal variations during the fragmentation process from start to finish. The images show that the temperature of the oil sand block was constant at approximately -16 °C. The temperature of the debris was recorded to be higher (close to 25 °C) due to the heat transfer from the cutter and the low rate of thermal diffusion through the oil sand.

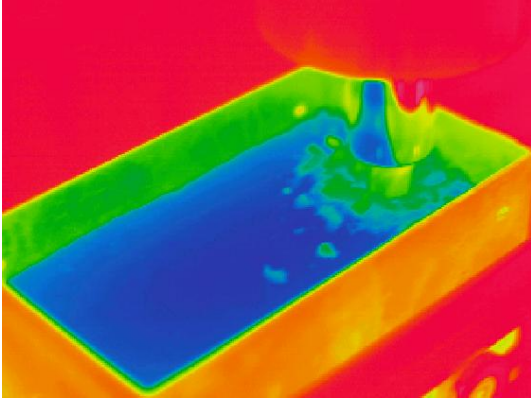

Figure 5-8 Thermal distribution during the fragmenting process

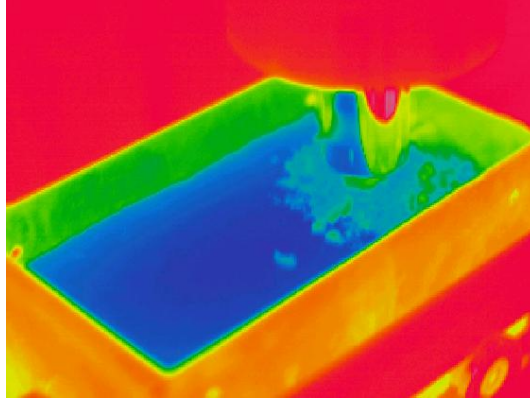

Figure 5-9 Thermal distribution during the fragmenting process

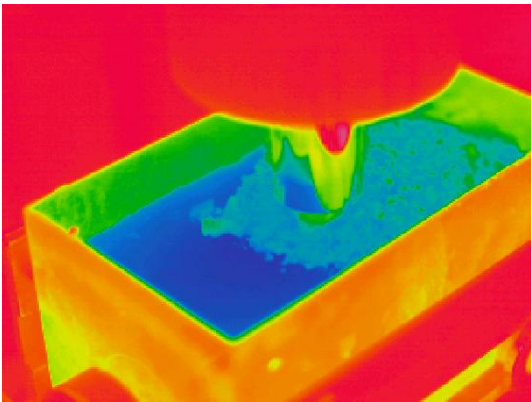

Figure 5-10 Thermal distribution during the fragmenting process

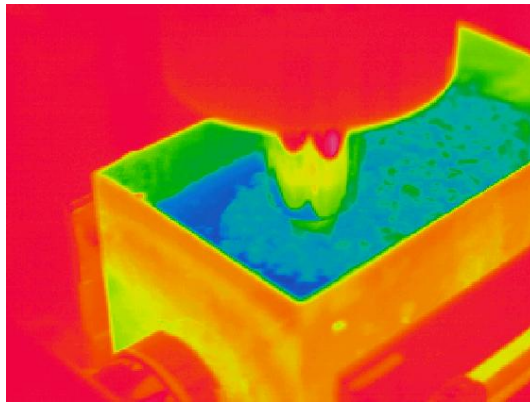

Figure 5-11 Thermal distribution during the fragmenting process

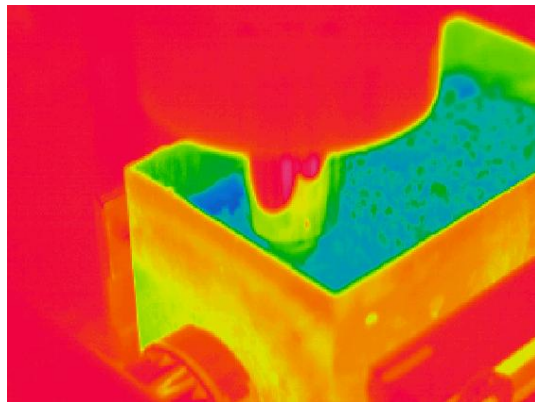

Figure 5-12 Thermal distribution during the fragmenting process

5.7 Digital Microscopy of Tool Tip

Since wear is an ongoing maintenance challenge in an oil sands environment, digital microscopy was used to qualitatively determine the impact the cutter experienced while fragmenting the oil sand blocks.

Originally, a high speed steel cutter was used. However, after approximately 30 mins of aggregated test time, the steel cutter was completely dull to a point where tactile contact over the cutting edge proved to be harmless. It was then decided that in order to maintain cutting effectiveness, a cutter composed of a different material was required. Therefore, a tungsten carbide cutter with replaceable inserts was used. These inserts were viewed under a Zeiss digital microscope before and after the tests to observe for wear.

The first four images were taken when the inserts were new and establishes a baseline for comparison. Figure 5-13 and Figure 5-14 are images of the cutting corner at 10 times magnification and at 63 times magnification for a new insert.

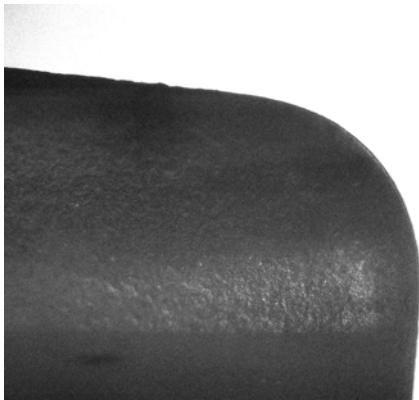

Figure 5-13 Cutting corner of a new removable insert at 10x magnification

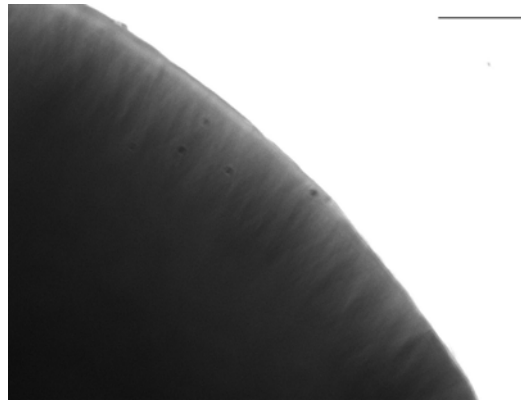

Figure 5-14 Cutting corner of a new removable insert at 63x magnification

Figure 5-15 and Figure 5-16 are images of the cutting edge at 10 times magnification and at 63 times magnification for a new insert.

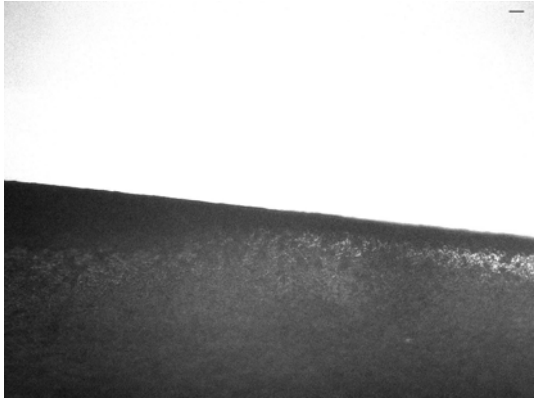

Figure 5-15 Cutting edge of a new removable insert at 10x magnification

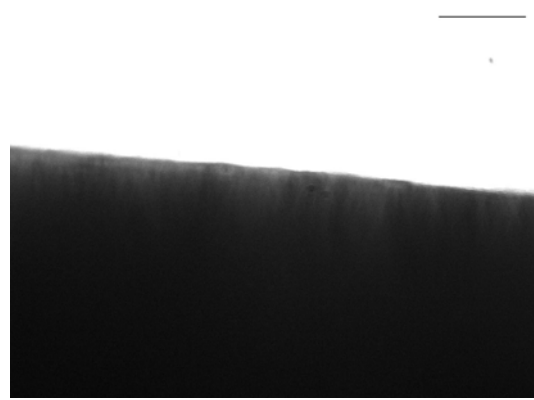

Figure 5-16 Cutting edge of a new removable insert at 63x magnification

The last four images were taken after nearly 278 mins of cumulative test time.

Figure 5-17 and Figure 5-18 are images of the cutting corner at 10 times magnification and at 63 times magnification for a used insert.

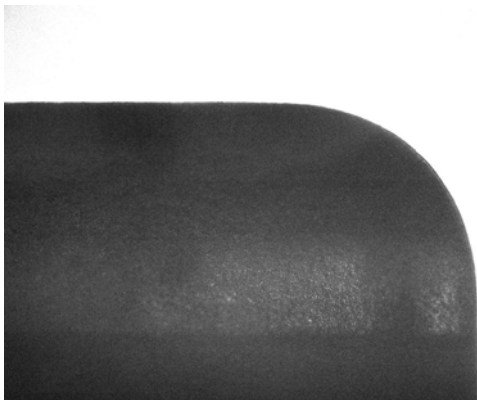

Figure 5-17 Cutting corner of a used removable insert at 10x magnification

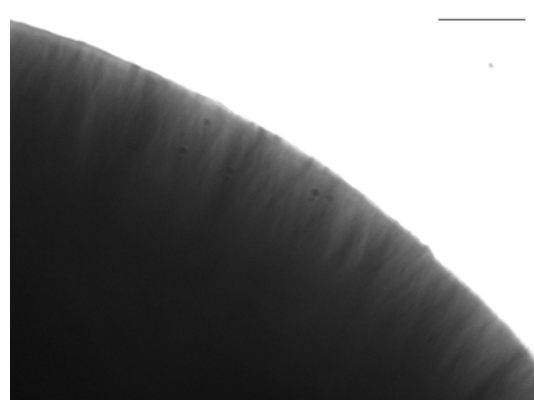

Figure 5-18 Cutting corner of a used removable insert at 63x magnification

Figure 5-19 and Figure 5-20 are images of the cutting edge at 10 times magnification and at 63 times magnification for a used insert.

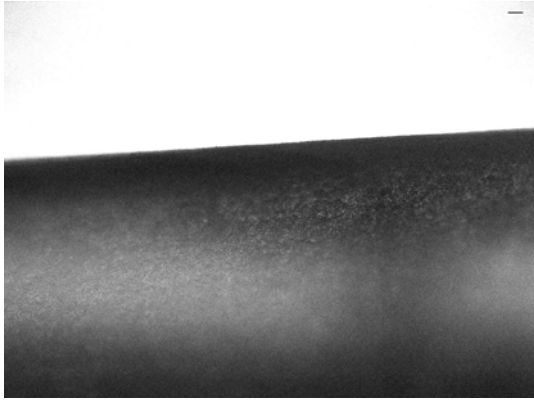

Figure 5-19 Cutting edge of a used removable insert at 10x magnification

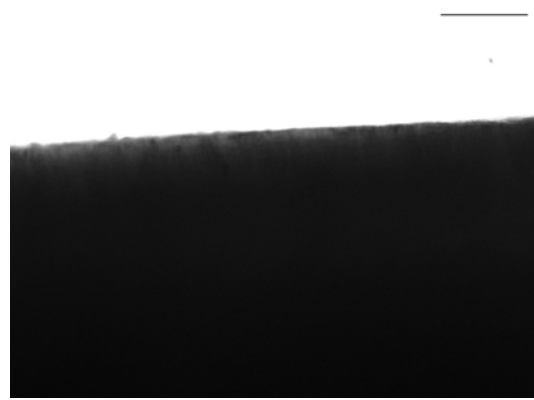

Figure 5-20 Cutting edge of a used removable insert at 63x magnification

From visual observations using a digital microscope, wear is negligible given such low use. From a tactile sense, the new and used tungsten carbide cutting inserts remained sharp.

In conclusion, the high speed steel cutter was dulled to a point where tactile engagement (rubbing one's finger on the cutting edge) proved to be harmless only after approximately 30 mins of test time, whereas the tungsten carbide cutter was still sharp after nearly 278 mins of testing. Therefore, it is evident that material selection will be critical for the overall reliability of the system concept and that tungsten carbide cutters be used to prevent premature wear. In addition, it is recommended that other proposed materials be tested in a lab environment prior to committing to costly field trials.

5.8 Fragmentation Tests

Fragmentation tests were carried out to investigate and determine the torque required to cut oil sand as well as the imparted load in the oil sand blocks. The following discussion outlines the results of these tests for both room temperature and frozen oil sand blocks in dry and wet cutting environments.

5.8.1 Test Plan

In an attempt to simulate expected field conditions as accurately as possible, lab-scale tests were performed under various sample states and cutting environments. Three testing conditions were investigated; thawed and dry, thawed and wet, and finally frozen and dry. Testing parameters can be found in Table 5-3. A minimum of three trials were carried out for each test while some tests were repeated multiple times due to data scattering and to ensure repeatability.

Table 5-3 Test matrix

Feed rate (in/min)	Feed rate (mm/s)	Rotational speed (rpm)	Sample state	Cutting environment
1.6	0.68	200	Thawed/Frozen	Dry/Wet
		300		
		400		
2.3	0.97	200	Thawed/Frozen	Dry/Wet
		300		
		400		
3.2	1.35	200	Thawed/Frozen	Dry/Wet
		300		
		400		
4.7	1.99	200	Thawed/Frozen	Dry/Wet
		300		
		400		
6.9	2.92	200	Thawed/Frozen	Dry/Wet
		300		
		400		

Table 6-3 Test matrix continued

Feed rate (in/min)	Feed rate (mm/s)	Rotational speed (rpm)	Sample state	Cutting environment
10.3	4.36	200	Thawed/Frozen	Dry/Wet
		300		
		400		
13.7	5.80	200	Thawed/Frozen	Dry/Wet
		300		
		400		
19.8	8.38	200	Thawed/Frozen	Dry/Wet
		300		
		400		
27.5	11.64	200	Thawed/Frozen	Dry/Wet
		300		
		400		

5.8.2 Data Processing

After completing each test, a data set was produced and plotted to view the cutting process. All data sets exhibited an initial surge or a peak which was indicative of the cutter engaging the oil sand block. Figure 5-21 illustrates a time series of data with a noticeable peak indicating initial cutter engagement into the oil sand block.

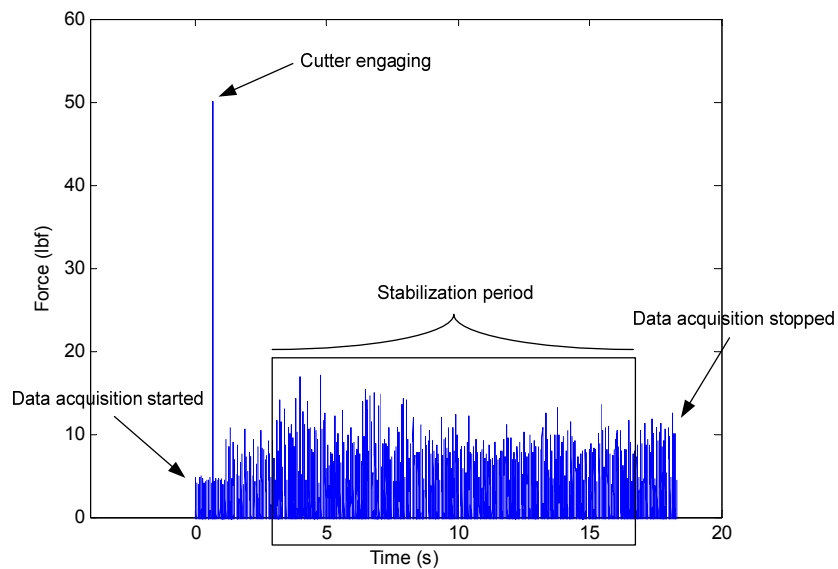

Figure 5-21 A data set of the cutting process

As shown in the above figure, the data began to stabilize after the cutter engaged the block. When processing the data, the surge was ignored. Data processing occurred when the data set stabilized (when the cutter was fragmenting the sample). A program was written in a Matlab programming environment for data processing to determine the average force during a cutting trial. This program incorporated calibration parameters and was used to view the data set as well as to convert the data set into a time domain. First, each data set was loaded and the program was executed which yielded the number of data points and the cutting time that the cutter was in the oil sand block. The data set was viewed for a stabilization period. This information was inputted into the program along with the number of data points (the array size) and the cutting time (which was calculated based on the array size and sampling rate). From the stabilized region, the program outputted the values for force and torque. These values were recorded and converted into appropriate units and plotted.

5.8.3 Sampling Rate

The sampling rate of a measurement system has a considerable effect the interpretation and reconstruction of a continuous signal in a time domain. The sampling rate is directly proportional to the signal. In other words, as the sampling rate decreases, the amount of information per unit time that defines the signal also decreases which can be misleading. Specifically, when a signal is sampled at a rate less than twice its highest frequency, the higher frequency content of the signal will be perceived as lower frequency content. This phenomenon is known as aliasing. In order to prevent the effects of possible aliasing, the sampling theorem was taken into consideration. This theorem states that to reconstruct the frequency content of a measured waveform accurately, the sampling rate must be greater than twice the highest frequency contained in the measured signal. Preliminary data were used to select an appropriate sampling frequency of 5 kHz.

5.8.4 Dry Oil Sand Fragmentation Tests

This section explains the results and discusses the dry oil sand tests. Figure 5-22 illustrates how force varies as rotational speed is increased for differing feed rates. Appropriate feed rates were selected based on the chip loading criteria mentioned earlier in Chapter 5 (Experimental Setup). The general trend shows that force is dependent on rotational speed and feed rate. As the rotational speed was increased, force increased as well. Increasing feed rates also contributed to an increase in force readings. However, at relatively low feed rates (0.68 mm/s to 1.99 mm/s) force measurements were between 30 N to 40 N and were not easily distinguishable from each other. This is because the cutter is removing material in a sufficient manner adhering to the chip loading criteria. On the contrary, relatively higher feed rates (2.92 mm/s to 5.80 mm/s) exhibited more discernable force readings in the range of 45 N to 100 N.

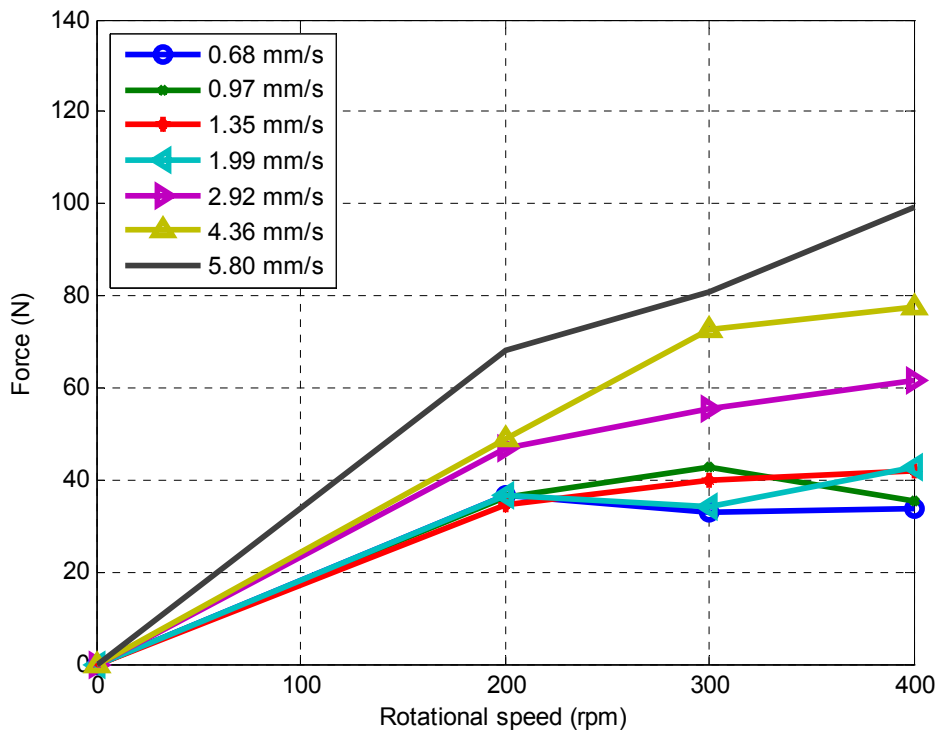

Figure 5-22 Force as a function of rotational speed for dry oil sand

Figure 5-23 depicts the relationship between torque and rotational speed for several feed rates. Torque increases with increasing rotational speeds and does not appear to be significantly impacted or distinguishable with increasing feed rates. All torque readings were relatively low and lie within a range of 3 N-m to 6 N-m. It is hypothesized that the reason for such low torque values is due to the frictional heat transfer from the cutter to the bitumen in the oil sand causing the oil sand matrix to dissociate.

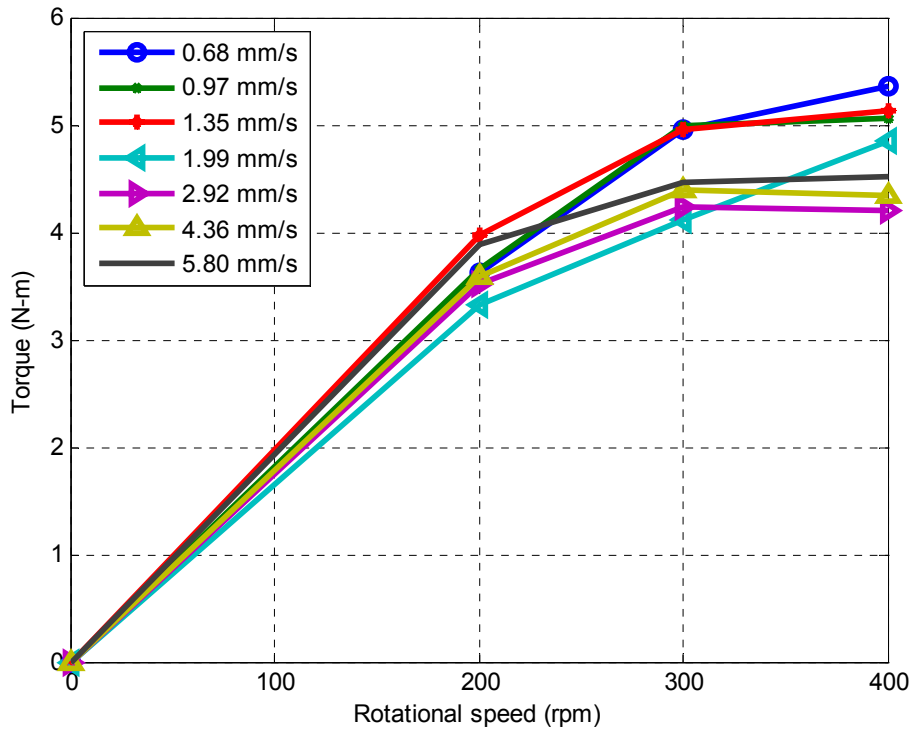

Figure 5-23 Torque as a function of rotational speed for dry oil sand

Figure 5-24 is a representation of how force changes with respect to feed rate at a constant rotational speed. From the chip loading criteria, a 400 rpm rotational speed was used to allow for sufficient debris removal. From the figure, it can be seen that there is a correlation between force and feed rate. It is evident that force increases with increasing feed rates. The figure also shows the range of data points that were obtained for each feed rate. It is apparent that there is some scattering of data. Lee et al. (2008) also obtained large levels of variations in their cutting force measurements. Li et al. (2005) stated that variations in measured forces are due to the presence of cutter runout. Discussion regarding this observation can be found in the section on sources of error later in this chapter.

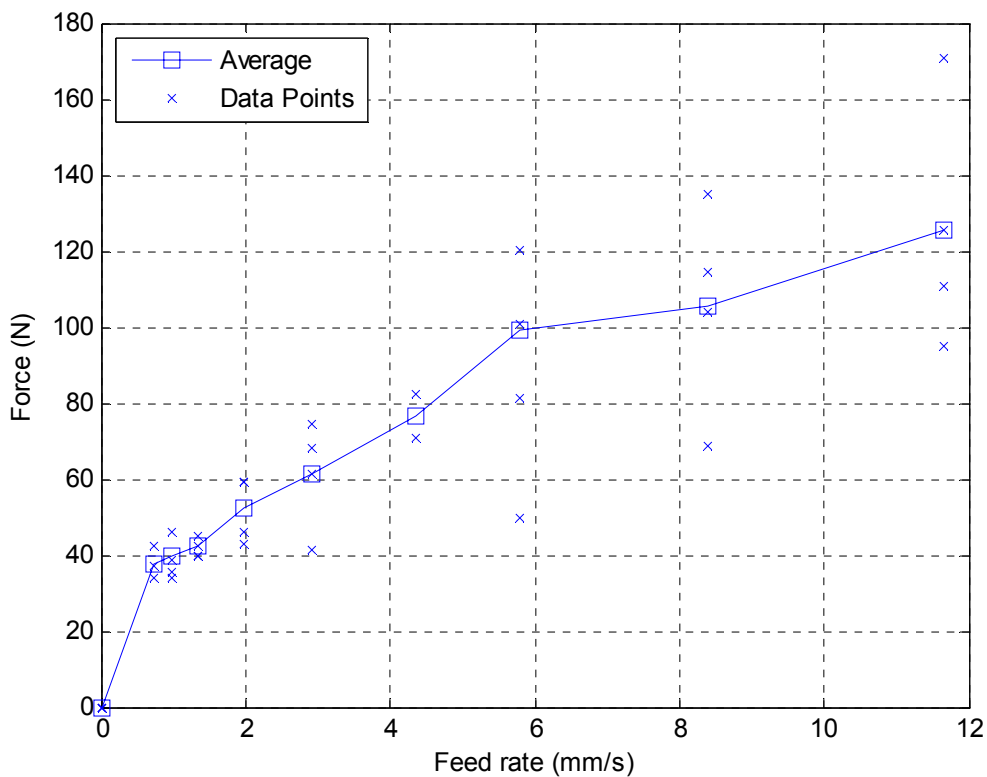

Figure 5-24 Force as a function of feed rate for dry oil sand

Figure 5-25 is a depiction how torque varies with feed rate at a set rotational speed. Similar to Figure 5-24, a constant rotational speed of 400 rpm was used. From the chip loading criteria, a 400 rpm rotational speed was used to allow for sufficient debris removal. In Figure 5-25, it can be observed that torque stays relatively constant as feed rate is increased. All torque readings were relatively low and lie within a range of 3.5 N-m to 5.5 N-m. It is hypothesized that the reason for such low torque values is due to the frictional heat transfer from the cutter to the bitumen in the oil sand causing the oil sand matrix to dissociate. Data scattering for torque measurements was less compared to the data scattering for force measurements. Discussion regarding this observation can be found in the sources of error section of this chapter.

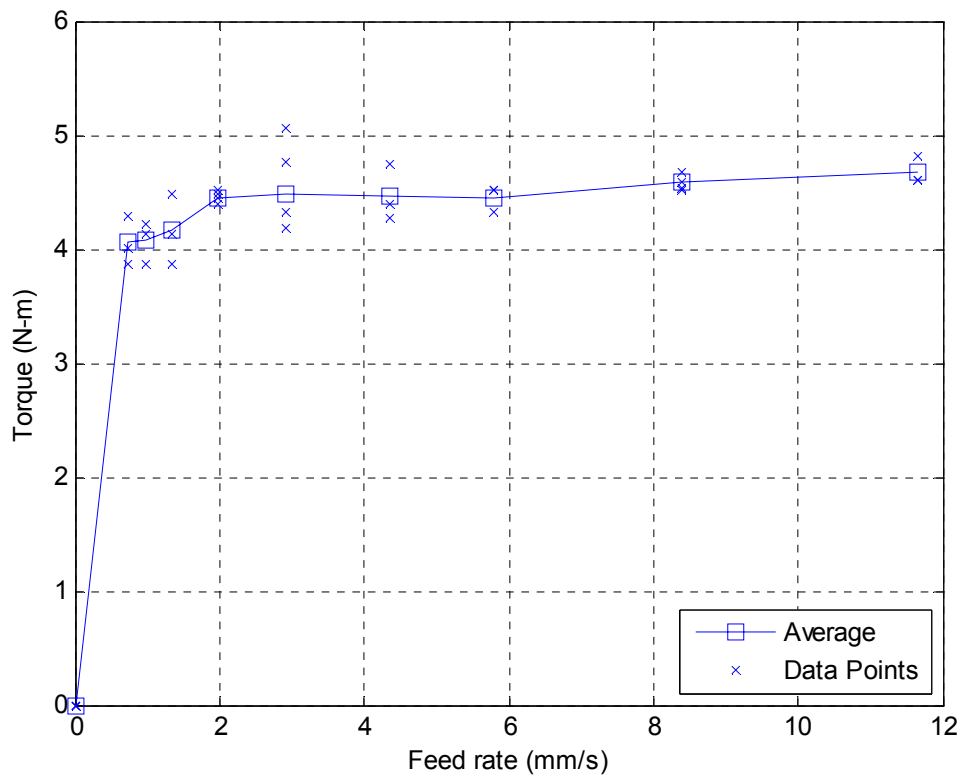

Figure 5-25 Torque as a function of feed rate for dry oil sand

5.8.5 Wet Oil Sand Fragmentation Tests

This section describes the results and discusses the wet oil sand tests. Figure 5-26 illustrates how force varies as rotational speed is increased for differing feed rates. Appropriate feed rates were selected based on the chip loading criteria mentioned earlier in Chapter 5 (Experimental Setup). The general trend shows that force is dependent on rotational speed and feed rate. As the rotational speed was increased, force increased as well. Increasing feed rates also contributed to an increase in force readings. An interesting observation was made when conducting tests in water; force decreases with the addition of water. This phenomenon may occur because water acts to dislocate the grain contacts of the interlocking structure of the oil sand particles, or it may simply be a reduction in friction due to lubrication between the tool and the oil sand.

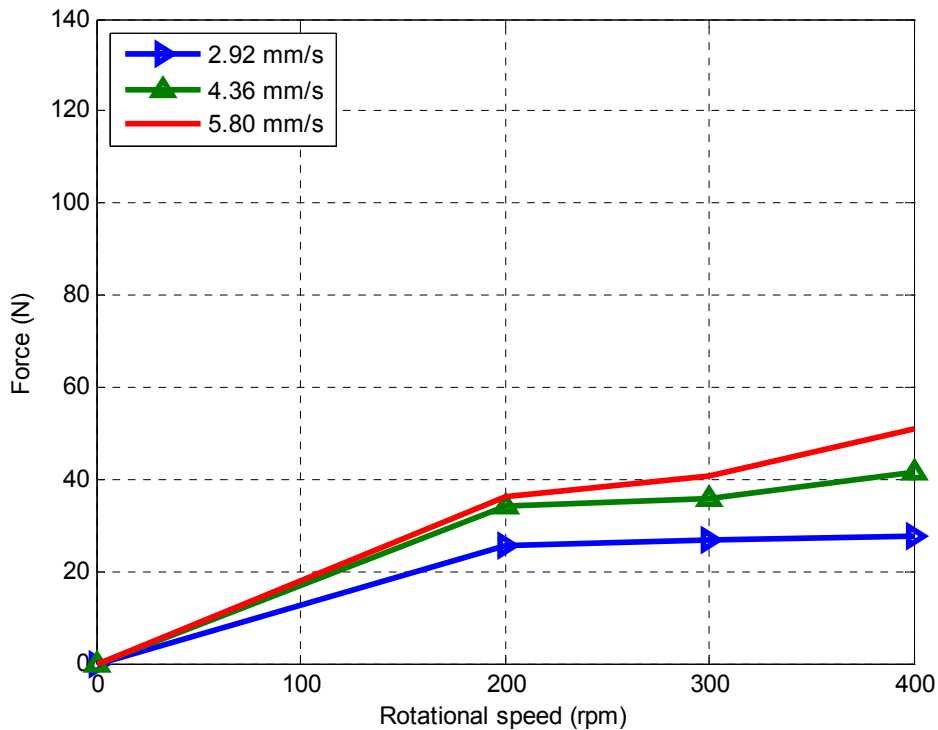

Figure 5-26 Force as a function of rotational speed for wet oil sand

Figure 5-27 depicts the relationship between torque and rotational speed for several feed rates. Similar to Figure 5-23, torque increases with increasing rotational speeds and does not appear to be significantly effected or discernable with increasing feed rates even though these tests were conducted in water. All torque readings were relatively low and lie within a range of 3 N-m to 5 N-m. It is hypothesized that the reason for such low torque values is due to the frictional heat transfer from the cutter to the bitumen in the oil sand causing the oil sand matrix to dissociate. Interestingly, water does not appear to have a major effect on torque in the range of conditions tested.

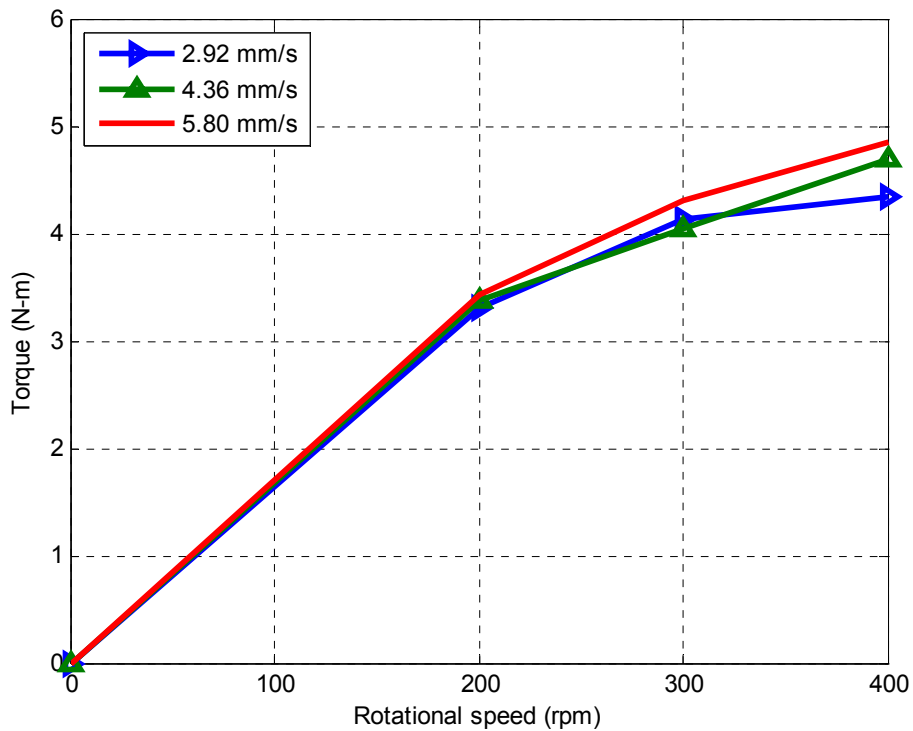

Figure 5-27 Torque as a function of rotational speed for wet oil sand

Figure 5-28 describes how force varies with respect to increasing feed rates while the cutter was kept at a constant rotational speed. According to the chip loading criteria, 400 rpm was used to allow for sufficient removal of debris. From the figure, it can be seen that there is a correlation between force and feed rate. It is evident that force increases with increasing feed rates. The figure also shows the range of data points that were obtained for each feed rate. It is apparent that there is some scattering of data. Lee et al. (2008) also obtained large levels of variations in their cutting force measurements. Li et al. (2005) stated that variations in measured forces are due to the presence of cutter runout. Discussion regarding this observation can be found in the sources of error section.

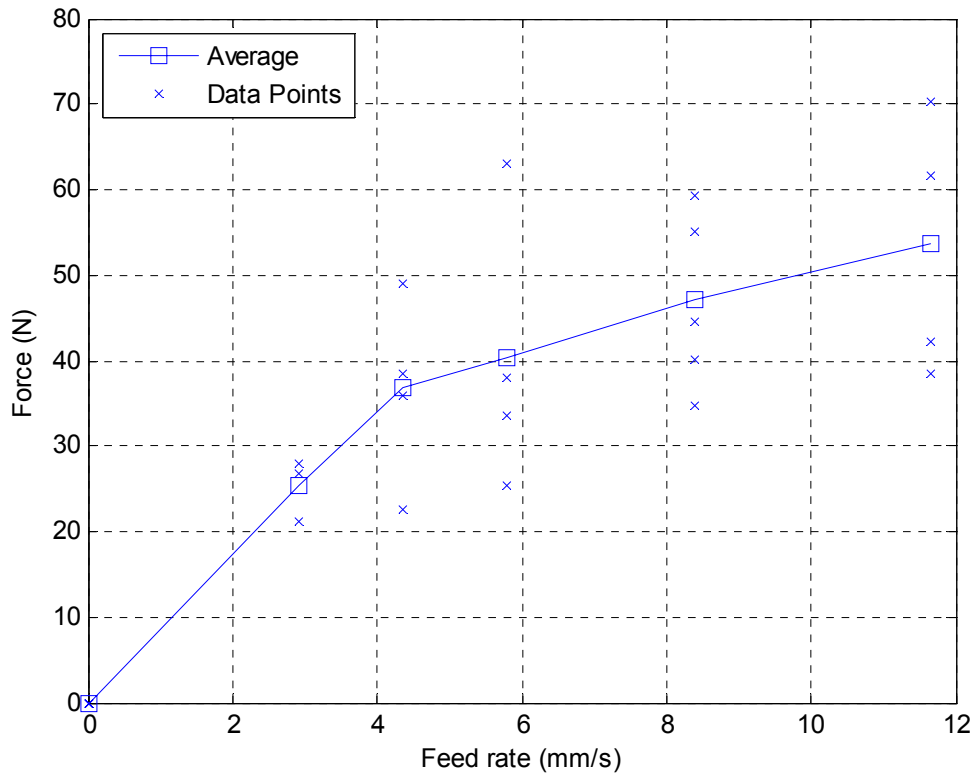

Figure 5-28 Force as a function of feed rate for wet oil sand

Figure 5-29 shows how torque varies with changing feed rates while the mill was set a constant rotational speed of 400 rpm to permit for sufficient debris removal. In Figure 5-29, it can be seen that torque remains relatively constant as feed rate is increased. All torque readings were relatively low and lie within a range of 4 N-m to 6 N-m. It is hypothesized that the reason for such low torque values is due to the frictional heat transfer from the cutter to the bitumen in the oil sand causing the oil sand matrix to dissociate. Data scattering for torque measurements was less compared to the data scattering for force measurements. Discussion regarding this observation can be found in the sources of error section.

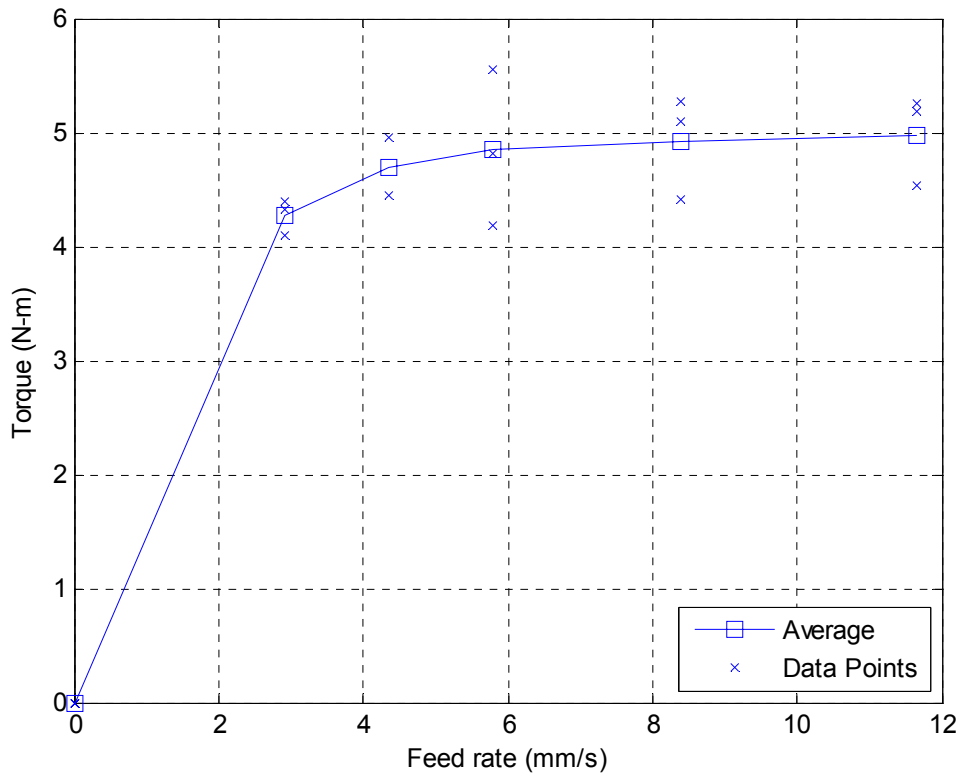

Figure 5-29 Torque as a function of feed rate for wet oil sand

5.8.6 Frozen Oil Sand Fragmentation Tests

This section presents and discusses the results for a set of tests with frozen oil sand. Frozen tests ceased at a feed rate of 4.7 in/min (1.99 mm/s) and 400 rpm due to previous experience with detrimental damage to equipment. Figure 5-30 illustrates how force varies as rotational speed is increased for differing feed rates. The general trend shows that force is influenced by rotational speed and feed rate. As rotational speed was increased, force increased as well. Increasing feed rates also led to an increase in force readings. As was anticipated, cutting frozen oil sand will result in higher cutting force readings. This observation can be readily seen when comparing Figure 5-30 to Figure 5-22. However, this observation is more apparent when comparing Figure 5-32 to Figure 5-24.

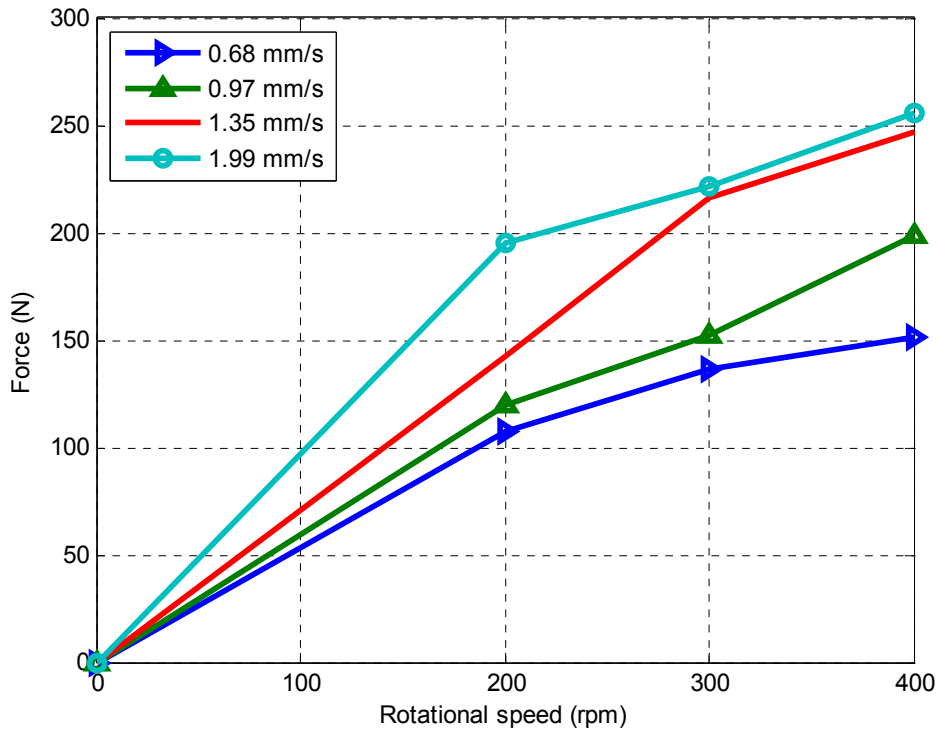

Figure 5-30 Force as a function of rotational speed for frozen oil sand

Figure 5-31 depicts the relationship between torque and rotational speed for several set feed rates. Similar to Figure 5-23, torque seems to be constant and does not appear to be significantly impacted or distinguishable with increasing feed rates even though these tests were conducted in a frozen state. All torque readings were relatively low and lie within a range of 3 N-m to 5 N-m. It is hypothesized that the reason for such low torque values is due to the frictional heat transfer from the cutter to the bitumen in the oil sand causing the oil sand matrix to dissociate. Interestingly, frozen oil sand does not appear to have an effect on torque measurements at different feed rates in the range of conditions tested.

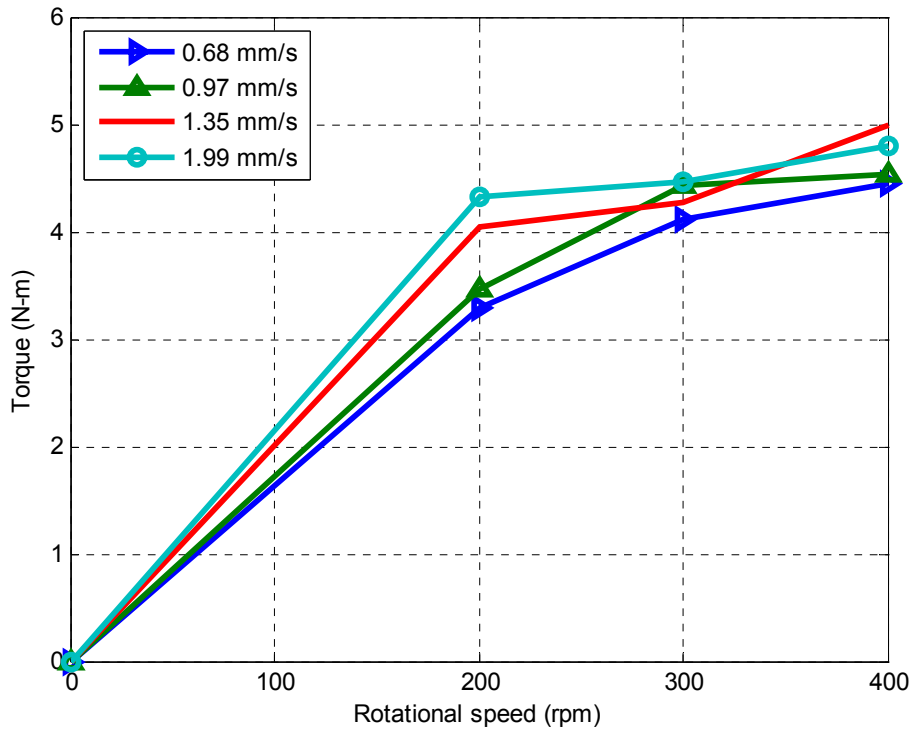

Figure 5-31 Torque as a function of rotational speed for frozen oil sand

Figure 5-32 describes how force varies with respect to increasing feed rates while the cutter was kept at a constant rotational speed. According to the chip loading criteria, 400 rpm was used to allow for sufficient removal of debris. From the figure, it can be seen that there is a correlation between force and feed rate. It is evident that force increases with increasing feed rates. The figure also shows the range of data points that were obtained for each feed rate. It is apparent that there is some scattering of data. Lee et al. (2008) also obtained large levels of variations in their cutting force measurements. Li et al. (2005) stated that variations in measured forces are due to the presence of cutter runout. Discussion regarding this observation can be found in the sources of error section. When comparing Figure 5-32 to Figure 5-24, it can be clearly seen that cutting oil sand in a frozen state results in approximately three times the force measurements when compared to cutting in a thawed state.

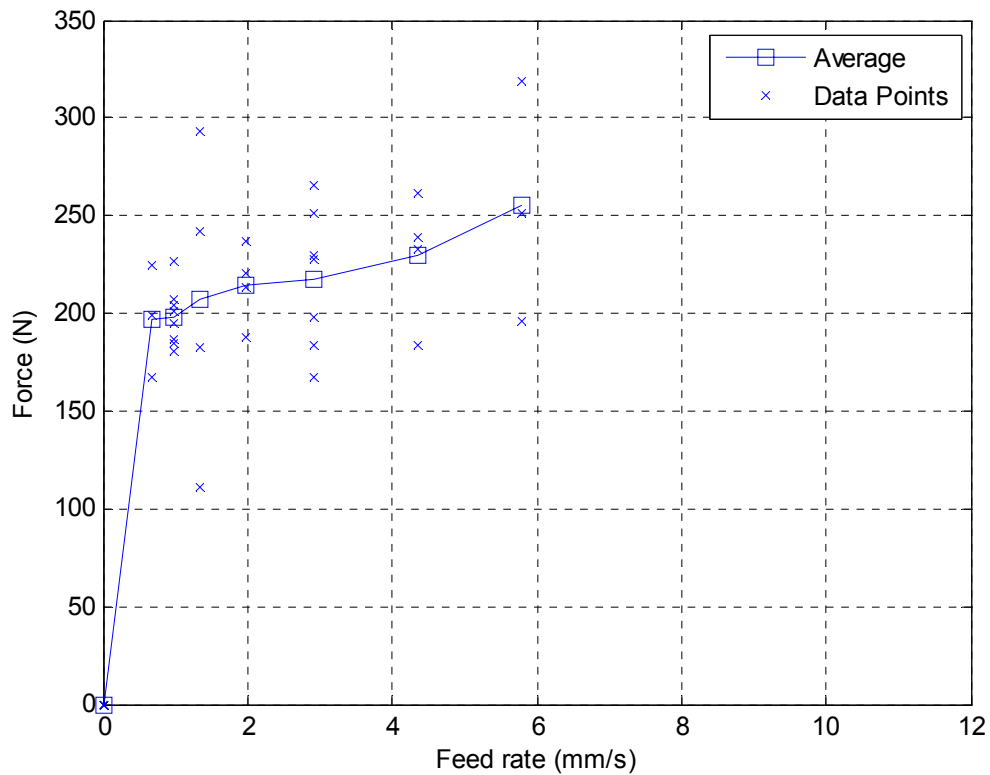

Figure 5-32 Force as a function of feed rate for frozen oil sand

It should be noted that in the above figure, force readings ceased at 13.7 in/min (5.80 mm/s) because of previous experience with detrimental damage to equipment. The maximum achievable feed rate the mill can reach is 27.5 in/min (11.64 mm/s). The above figure was plotted in a way for ease of comparison with previous plots.

Figure 5-33 shows how torque varies with changing feed rates while the mill was set a constant rotational speed of 400 rpm to permit for sufficient debris removal. In Figure 5-33, it can be seen that torque remains relatively constant as feed rate is increased. All torque readings were relatively low and lie within a range of 4 N-m to 6 N-m. It is hypothesized that the reason for such low torque values is due to the frictional heat transfer from the cutter to the bitumen in the oil sand causing the oil sand matrix to dissociate. Data scattering for torque measurements was less compared to the data scattering for force measurements. Discussion regarding this observation can be found in the *sources of error* section later on in this chapter. When comparing Figure 5-33 with Figure 5-25, it appears that torque increases slightly when cutting in frozen oil sand.

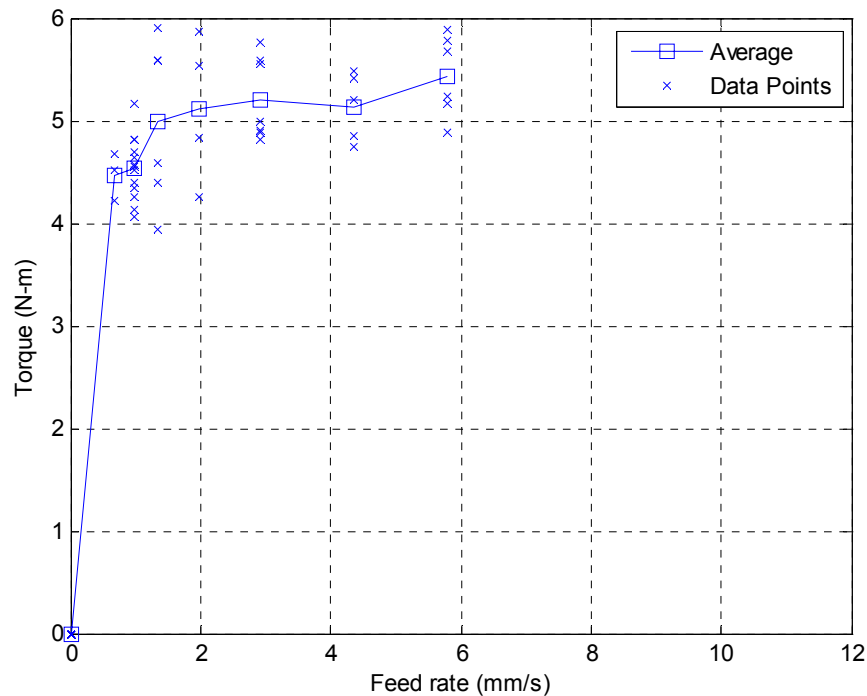

Figure 5-33 Torque as a function of feed rate for frozen oil sand

Similar to Figure 5-32, it should be noted that in the above figure, torque readings ceased at 13.7 in/min (5.80 mm/s) because of previous experience with detrimental damage to equipment. The maximum achievable feed rate the mill can reach is 27.5 in/min (11.64 mm/s). The above figure was plotted in a way for ease of comparison with previous plots.

5.8.7 Dry Oil Sand vs. Wet Oil Sand

This section compares the dry oil sand tests with the wet oil sand tests. Figure 5-34 is a plot of force as a function of feed rate in dry and wet cutting environments. From the figure, it can be clearly seen that the addition of a fluid such as water can lower the cutting force because water loosens the interlocking oil sand structure. Therefore, it is recommended that the system concept use a fluid which will not only assist in reducing cutting force, but also aid in slurry transport to the surface.

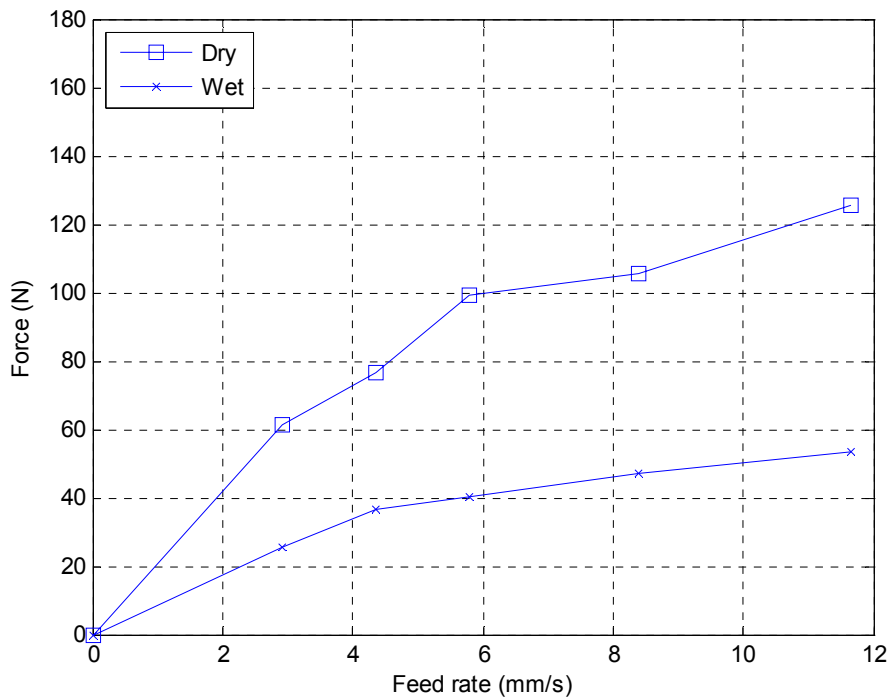

Figure 5-34 Force as a function of feed rate in dry and wet conditions

Figure 5-35 is a representation of torque as a function of feed rate in dry and wet cutting conditions. In the figure, it can be seen that torque remains relatively constant as feed rate is increased. Also, changing the cutting environment does not appear to have a significant effect on torque. Torque measurements were low and lie within a narrow of 4 N-m to 5 N-m. It is conjectured that the reason for such low torque values is due to the frictional heat transfer from the cutter to the bitumen in the oil sand matrix to causing the oil sand particles to dissociate.

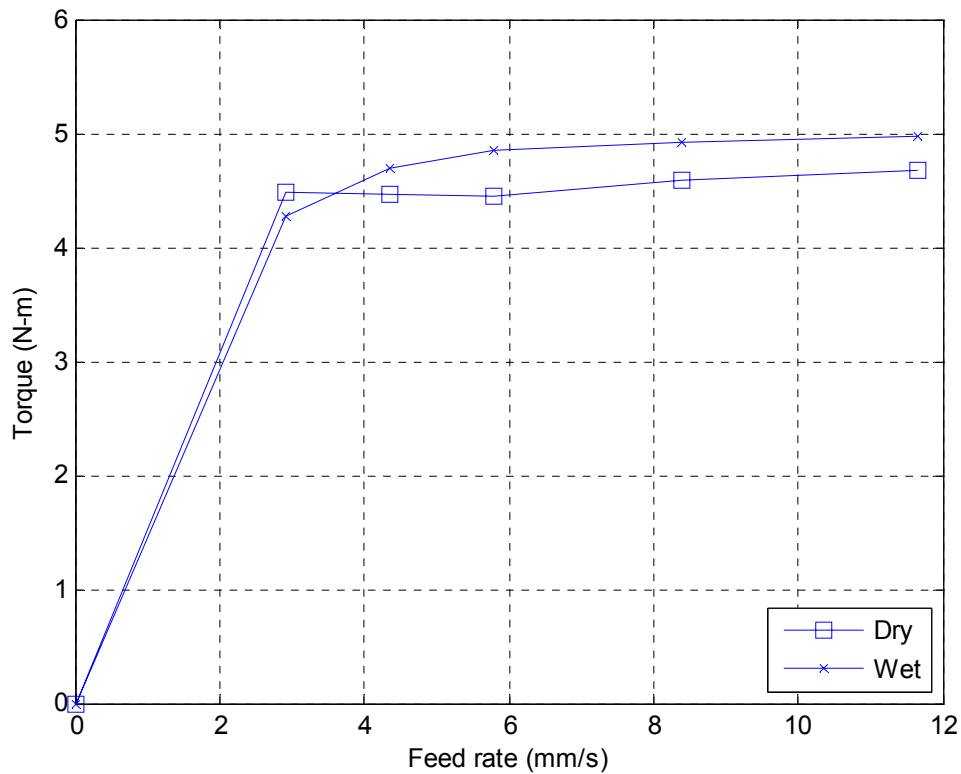

Figure 5-35 Torque as a function of feed rate in dry and wet conditions

Figure 5-36 depicts how force varies with increasing rotational speeds in dry and wet cutting environments. The trend shows that increasing rotational speed leads to an increase in force. Also, it is observed that the use of a fluid lowers force readings because the water acts to dislocate the grain contacts of the interlocking structure of the oil sand particles.

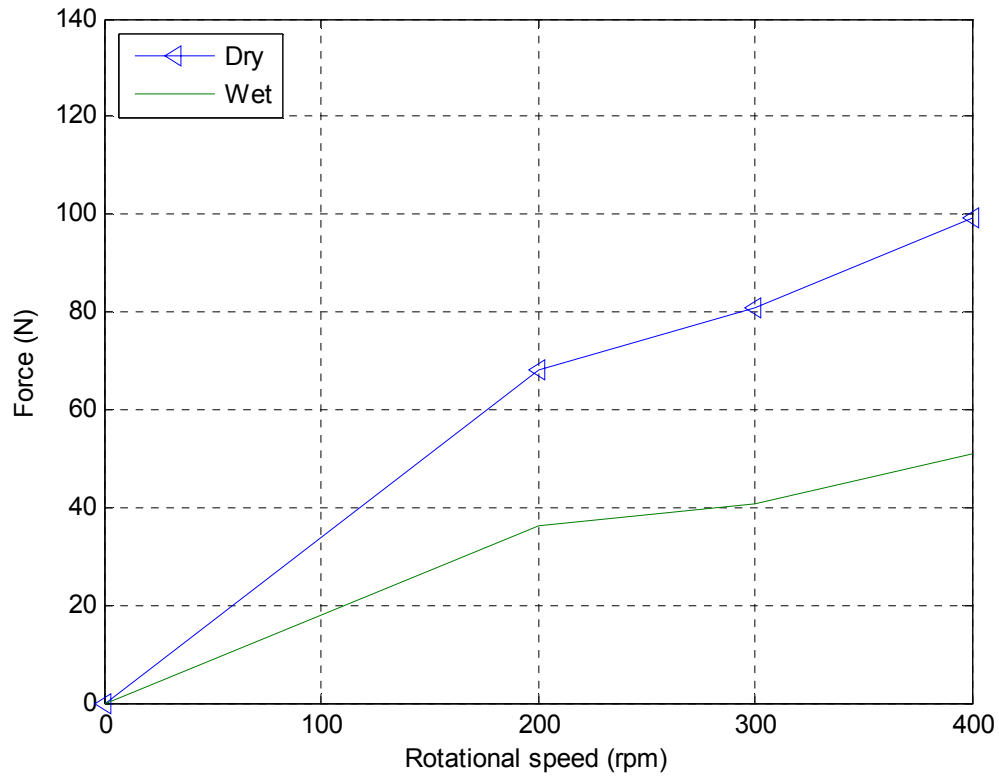

Figure 5-36 Force as a function of rotational speed in dry and wet conditions

Figure 5-37 illustrates how torque behaves with increasing rotational speeds under dry and wet cutting conditions. From the figure, torque increases with increasing rotational speeds. However, torque does not appear to be significantly affected by adding water. Frictional heat transfer from the cutter to the bitumen in the oil sand is suspected for such low torque values.

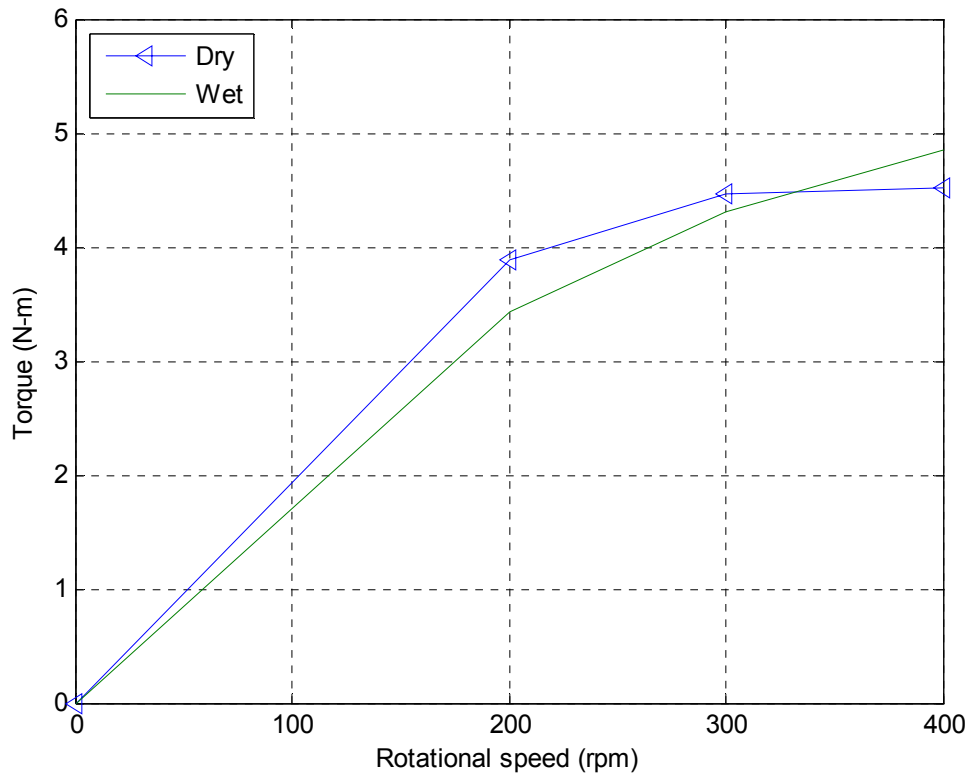

Figure 5-37 Torque as a function of rotational speed in dry and wet conditions

5.8.8 Thawed Oil Sand vs. Frozen Oil Sand

This section compares the thawed oil sand tests with the frozen oil sand tests. Figure 5-38 is a plot of force as a function of feed rate in thawed and frozen cutting environments. From the figure, it can be clearly seen that force and feed rate are dependent. Also, cutting through frozen oil sand requires a greater amount of force. It is suspected that this observation is due to the shape of the oil sand particles which provides a natural particle interlock. This interlocking structure is further magnified by the presence of frozen bitumen which acts as an adhesive.

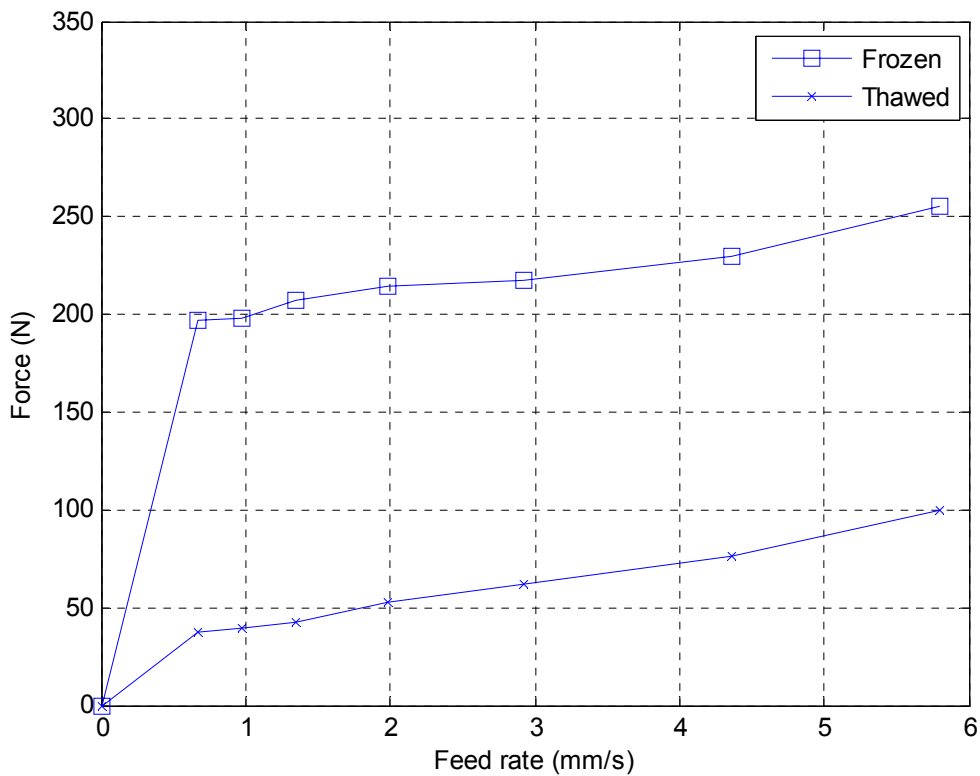

Figure 5-38 Force as a function of feed rate in frozen and thawed conditions

Figure 5-39 is a representation of torque as a function of feed rate in thawed and frozen cutting conditions. In the figure, it can be seen that torque remains relatively constant as feed rate is increased. Also, cutting in a frozen environment appears to have a slight increase on torque. Similar to previous findings, torque values were relatively low and are situated within a range of 4 N-m to 5.5 N-m. It is hypothesized that this observation is due to the frictional heat transfer from the cutter to the bitumen in the oil sand matrix causing the oil sand particles to dissociate.

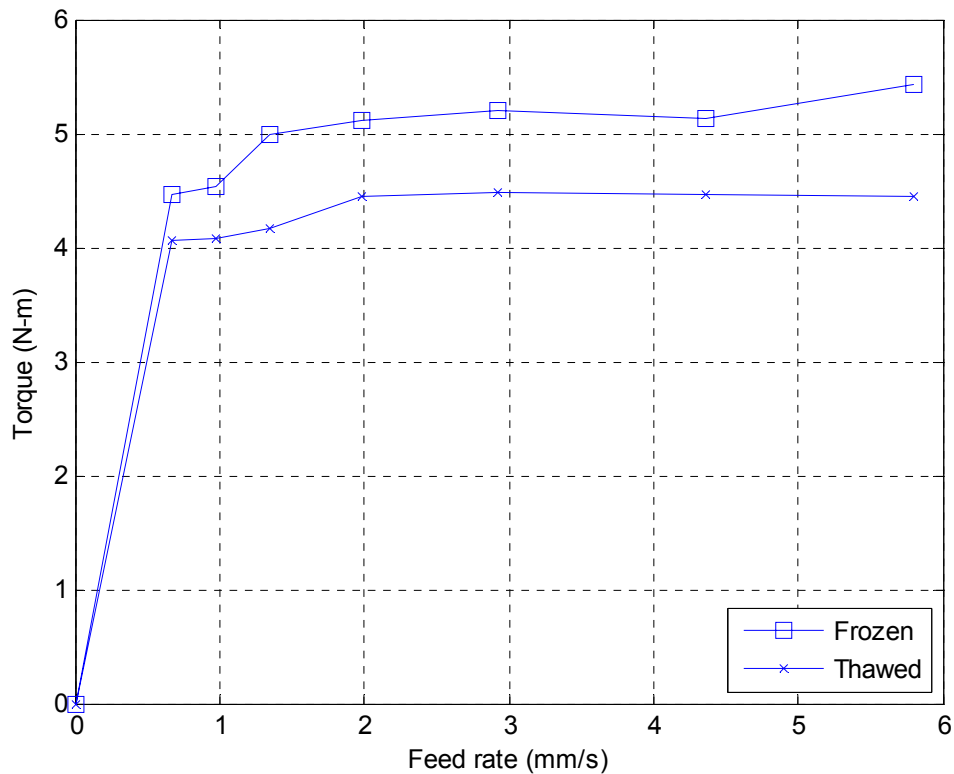

Figure 5-39 Torque as a function of feed rate in frozen and thawed conditions

Figure 5-36 depicts how force varies with increasing rotational speeds in thawed and frozen cutting environments. The overall trend shows that force is dependent on rotational speed. Specifically, increasing rotational speed leads to an increase in force. From the figure, it can be seen that a greater amount of force is necessary to cut oil sand in a frozen state. As stated earlier, it is suspected that this observation is due to the shape of the oil sand particles which provides a natural particle interlock. This interlocking structure is further magnified by the presence of frozen bitumen which acts as an adhesive.

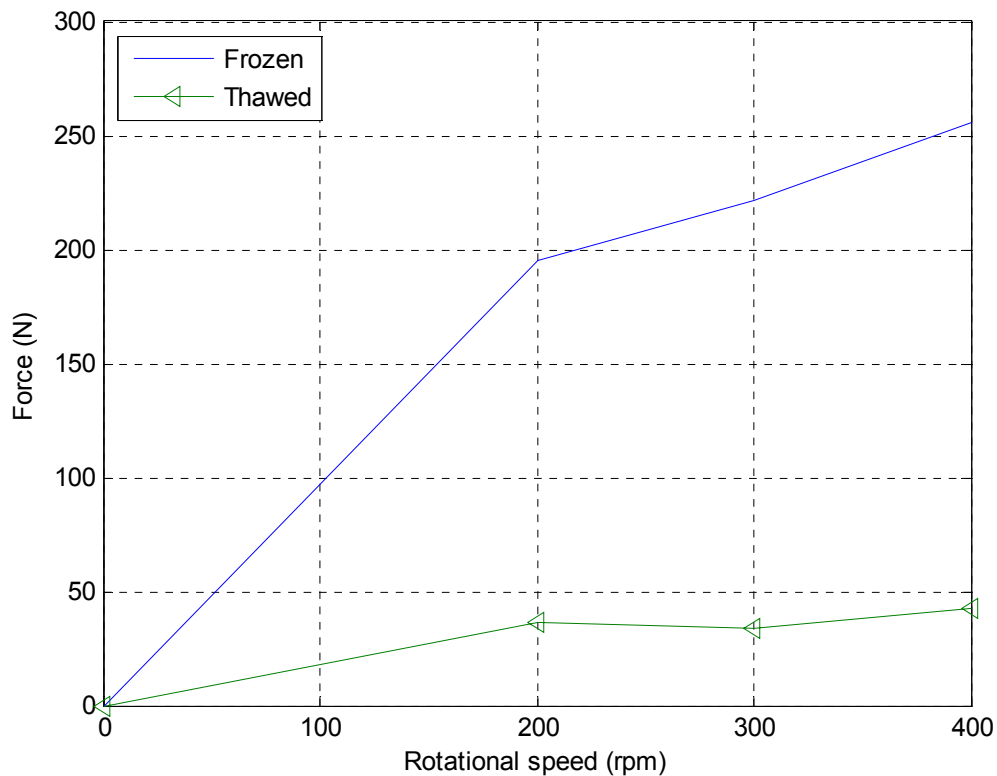

Figure 5-40 Force as a function of rotational speed in frozen and thawed conditions

Figure 5-41 is a representation of torque as a function of rotational speed in thawed and frozen cutting conditions. From the figure, it is observed that torque increases with increasing rotational speeds. Also, cutting in a frozen environment appears to have a slight increase in torque. However, it can be seen that at 400 rpm, the torque values overlap. The reason for this is that the heat generated from the spinning cutter started to dissociate the oil sand particles within the oil sand matrix. It is recommended that testing at higher rotational speeds should be performed to verify this reason.

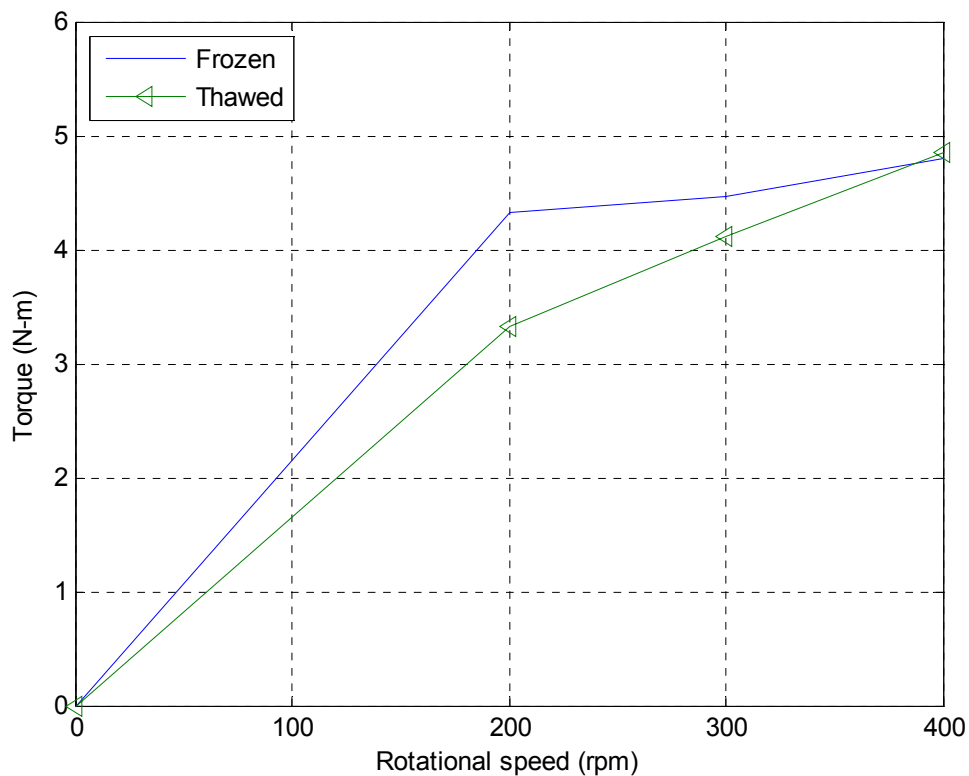

Figure 5-41 Torque as a function of rotational speed in frozen and thawed conditions

5.9 Analytical Modeling

Empirical results were compared against a steady-state cutting model. The Gill and Vanden Berg soil cutting model was chosen because it represents the cutting action of a full-scale implementation of the system concept. Gill and Vanden Berg stated that the horizontal force of a homogenous medium is a function of

shear plane angle, tool depth, tool speed, tool length, tool width, gravitational constant, specific weight, internal friction angle, external friction angle, cohesion, and rake angle (Blouin, 2001).

The Gill and Vanden Berg model (Blouin, 2001) can be written as:

$$F = \left\{ \left(\gamma \frac{\sin(\beta + \rho)}{\sin \rho} \right) \left(l + \frac{d \cos(\beta + \rho)}{2 \sin \rho} + \frac{d \sin(\beta + \rho) \tan \beta}{2 \sin \rho} \right) + \left(\frac{c}{\sin \rho (\sin \rho + \phi \cos \rho)} \right) + \left(\frac{\gamma v^2 \sin \beta}{g \sin(\beta + \rho) (\sin \rho + \phi \cos \rho)} \right) \right\} \quad (7.1)$$

$$\times \left[\frac{wd(\sin \beta + \delta \cos \beta)(\sin \rho + \phi \cos \rho)}{\sin(\rho + \beta)(1 - \phi \delta) + \cos(\rho + \beta)(\phi - \delta)} \right]$$

where	F = horizontal force	unknown	N
	ρ = shear plane angle		3 °
	d = tool depth	0.0127	m
	v = tool speed (angular speed + feed)	varies	m/s
	l = tool length	0.02	m
	w = tool width	0.0108	m
	g = gravitational constant	9.81	m/s ²
	γ = specific weight	950	kg/m ³
	ϕ = internal friction angle	28	°
	δ = external friction angle	25	°
	c = cohesion	17,000	kg/m ²
	β = rake angle	10	°

The shear plane angle, tool length, tool width, and rake angle were measured using a digital caliper. The tool depth was kept constant at 0.5 in (0.0127 m) in order to prevent chip overload which was explained in earlier chapters. Tool speed is the sum of angular speed and feed rate. Angular speed was kept constant at 400 rpm (42 rad/s) while feed rate was adjusted on the mill. Specific weight was assumed to be 2100 kg/m³ while internal friction angle and cohesion were empirically obtained from the shear tests. Results from shear testing revealed that the oil sand blocks had an internal friction angle of 28°. A cohesion of 17,000 kg/m² was assumed in the model to match the experimental data. From Hong (2001), external friction angle was 25°.

The model was adapted for the three cutting conditions by accounting for the friction angles. This was done by setting the dry condition as a baseline. Table 5-4 lists the parameters that were adjusted for the cutting conditions.

Table 5-4 Parameters adjusted for cutting conditions

Parameter	Cutting condition		
	Dry (°)	Wet (°)	Frozen (°)
Internal friction angle, ϕ	28	1.4	60
External friction angle, δ	25	1.25	50

Figure 5-42 shows the results of the dry and wet tests along with their respective analytical outputs. While the model did not exactly fit the data, the model does represent the data quite well as it can be seen by the display of within a similar order of magnitude. However, a similar trend is not apparent due to the minute changes in tool speeds which was a limitation of the mill.

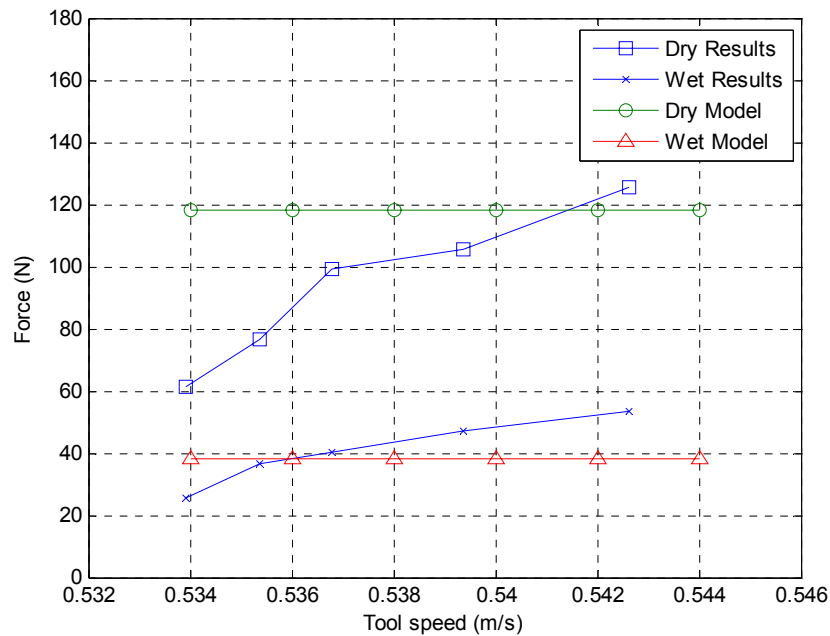

Figure 5-42 Empirical vs analytical results for force under dry and wet cutting conditions

Figure 5-43 depicts the experimental results with the analytical model under thawed and frozen test conditions. Similarly, it can be seen that the model and the experimental data correlate reasonably well. However, a similar trend is not apparent due to the small variations in tool speeds which was a limitation of the experimental equipment.

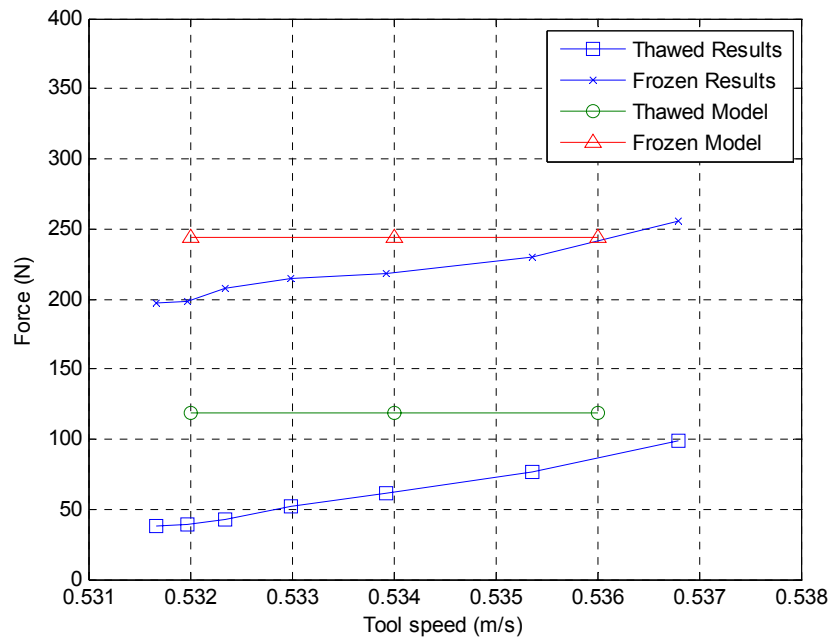

Figure 5-43 Empirical vs analytical results for force under thawed and frozen cutting conditions

Analytical modeling yielded favourable results. However, it is cautioned that there is some uncertainty with geotechnical parameters such as specific weight, friction angles, and cohesion since these can vary greatly depending on the depositional environments at which oil sand is found. The inconsistencies in these parameters make modeling a challenging task. This is due to the natural variability of oil sand strata depending on geographical location. Further geotechnical work is beyond on the scope of this thesis. Therefore, it is recommended that further testing be undertaken so that industrial scale-up will be successful.

5.10 Energy Consumption

In a milling operation, energy consumption during the machining process is the product cutting force and tool speed. Referring to the Machining and Metalworking Handbook, energy consumption can be determined using the following equation:

$$M = F_c v \quad (7.2)$$

where M = rate of energy consumption during machining W
 F_c = cutting force N
 v = tool speed m/s

This equation was used to compare the rate of energy consumption during machining for the different testing environments. Figure 5-44 is a comparison of the energy consumption between dry and wet cutting conditions. Taking the dry oil sand cutting condition as a baseline, it can be seen from the figure that adding a fluid (in this case, water) to the cutting process will result in lower energy requirements. This is true because the energy consumption equation is dependent on cutting force.

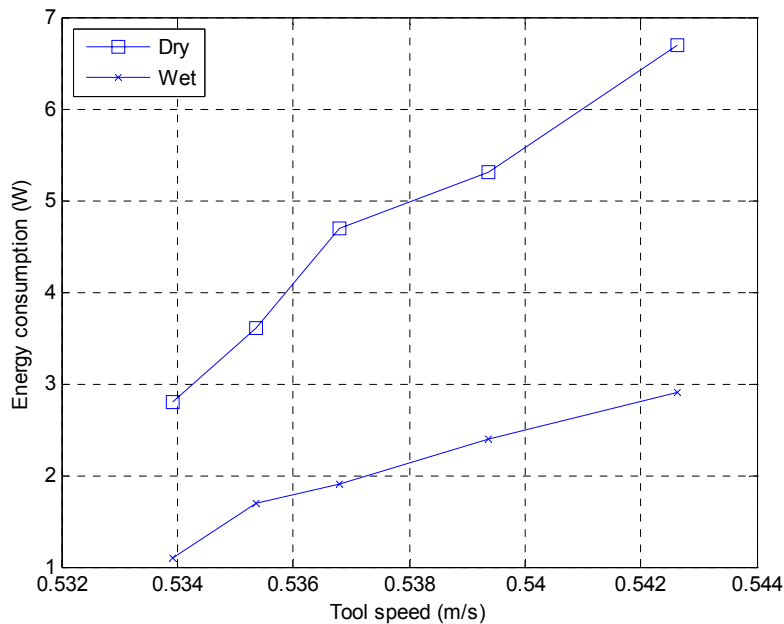

Figure 5-44 Energy consumption for dry and wet cutting conditions

Therefore, it is recommended that the system concept utilize a fluid while cutting. First, from an economic point of view, using a fluid will lower cutting force which will then lead to lower energy consumption. Second, from a technical standpoint, cutting with a fluid will assist in slurry transport of the ore to the surface. It should be noted that water was tested. However, cutting with a solvent should be investigated. Using a solvent will lower water consumption and should lessen the costs associated with water remediation.

Figure 5-45 depicts the relative increase in energy consumption associated with cutting frozen oil sand. The reader is cautioned that cutting frozen not only increases energy consumption, but will increase the likelihood of equipment damage. This was the case with the tests that were performed where the torque cell suffered detrimental damage that was beyond repair which resulted in downtime.

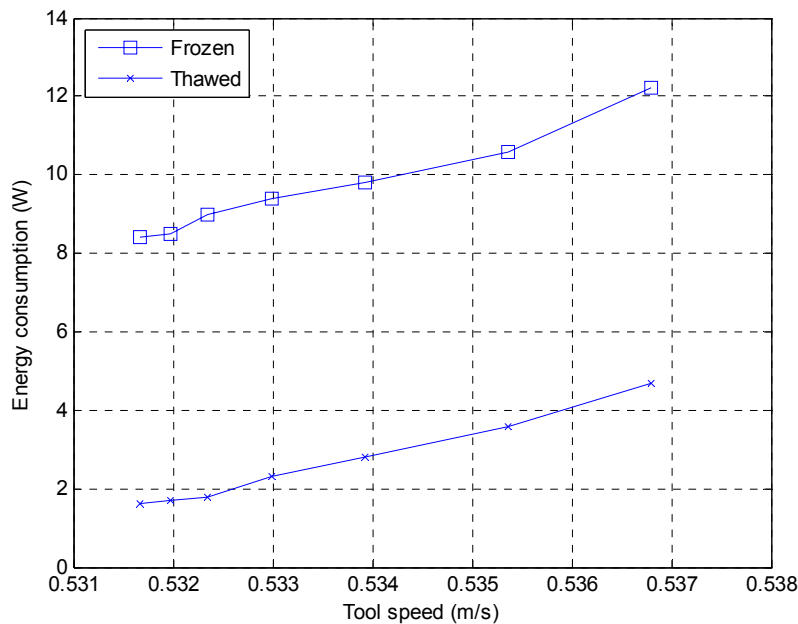

Figure 5-45 Energy consumption for frozen and thawed cutting conditions

Therefore, it is advised not to deploy the system concept to cut frozen oil sand unless proper safeguards are in place such as online tool condition monitoring and

spare parts are in stock. Also, from discussions with Syncrude Research personnel in early 2009, it was revealed that their Mine Operations group began blasting the mine face as a method of fragmenting oil sand (M. Anderson, personal communication, April 6, 2009). It is speculated the reason for this is to minimize energy consumption and lower wear on their ground engaging tools. Minimizing energy consumption and reducing wear will lower costs and increase equipment availability which is critical for profitability.

5.11 Machinability Factor

According to Shaw (2005), machinability is a general term used to rate ease of machining a material relative to tool life, surface finish produced, or power consumed. Due to the wide range of meaning involved, it is better to state the basis of comparison when two materials are compared relative to their machinability. The basic machinability of a material is a function of its chemistry, structure, and compatibility with tool material.

From the Machining and Metalworking Handbook, machinability can be calculated using the following relationship:

$$K = \frac{wdf_r}{C_{hp}} \quad (7.3)$$

where	K	=	machinability factor	$\text{in}^3/\text{min}/\text{hp}$
	w	=	cut width	in
	d	=	cut depth	in
	f_r	=	feed rate	in/min
	C_{hp}	=	horsepower at the cutter	hp

The mill used a motor that was rated at 3.58 hp. Horsepower at the cutter is defined as 80 – 90 % of the motor’s rating. Assuming the motor is 85 % efficient, the horsepower at the cutter is 3.04 hp.

Not only is machinability a function of cut width, cut depth, feed rate, and horsepower at the cutter, machinability is also dependent on other parameters such as the type of cutter, cutter geometry, and the material that one is cutting through.

The feed rate that was used to calculate the machinability factor was the feed rate that caused catastrophic equipment failure which was 19.8 in/min (8.38 mm/s) while cutting in the hardest environment (in the frozen state). Recall, that the cut width and cut depth was 0.5 in (12.7 mm).

Therefore, upon applying the machinability equation, the machinability factor based on a 1 in diameter single-tooth tungsten carbide cutter is 1.6. To give the reader a basis to compare against, the machability factor of a relatively hard material such as titanium is 0.75. Pertaining to the system concept, it is imperative that full-scale testing be done in order to accurately determine the machinability factor for such a system.

5.12 Sources of Error

Attempts were made to mitigate or reduce probable sources of error such as utilizing a design of experiment approach. However, as with any experiment, it is difficult to remove all sources of error. Reasons for some of the possible sources of error are explained.

5.12.1 Equipment Influences

The mill was purchased in 1971 and was decommissioned in 2004. In 2009, the mill was refurbished. The mill was in operation for 33 years and after five years of inactivity, the mill was refurbished for the oil sand cutting tests. Taking the age of the mill into consideration, the mill's feed rates were tested as a precautionary measure. Interestingly enough, it was determined that the indicated feed rates on the mill were not actual feed rates. Actual values were found to be

on average 10 % higher than indicated values. Figure 5-46 illustrates the exponential behaviour of the feed rates.

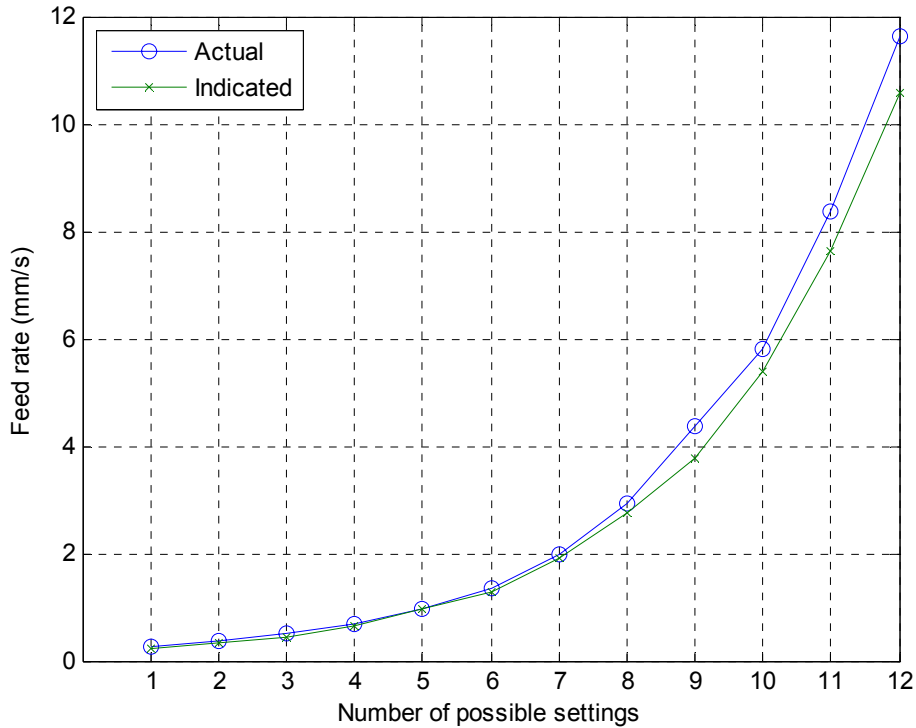

Figure 5-46 Feed rate trend

The mill was commissioned 38 years ago. It is suspected that the age of the mill had an effect on the controlled parameters. This suspicion was validated during experiments when it was noticed that rotational speed fluctuates. Before each run, rotational speed was set and was left to stabilize. After each test, rotational speed was noticed to periodically increase or decrease. This is due to the heating and cooling of the rubber belt in the belt-type variable speed gear box. Also, the belt's elasticity may be affected since the belt has not been replaced since commissioned 38 years ago. Therefore, it is recommended that the rubber belt be replaced to ensure a constant rotational speed.

5.12.2 The Milling Process

Electrical interference is a factor that may have contributed to data scattering. Data scattering was also addressed by Tarnng et al. (1993). They stated that this disturbance is due to cutter runout, which is an unavoidable phenomenon in milling operations affecting cutting performance. Li et al. (2005) also stated that variations in measured forces are due to the presence of cutter runout. More information concerning this common phenomenon is discussed in Li et al. (2004).

The nature of the milling process generates heat. It is hypothesized that the reason for such low torque values is due to the frictional heat transfer from the cutter to the bitumen in the oil sand causing the oil sand matrix to dissociate.

5.12.3 Sample Influences

Oil sand homogeneity is another factor. The oil sand was acquired from a single source. However, due to the natural characteristics of oil sand, it is difficult to ensure uniform properties throughout the sample. This factor was addressed by Fong et al. (2004) where they prepared their own oil sand. However, it was determined that their oil sand will not be applicable for the milling tests, since their oil sand was designed for flotation performance tests, not for mechanical testing as the milling tests would require.

5.12.4 Human Influences

Poor maintenance practices by earlier operators could have a negative effect on the performance and reliability of the mill. No maintenance records were found. As with any piece of equipment, proper maintenance is critical to maintain optimal performance.

5.13 Summary of Findings

To recap, the following tables summarize the findings of the oil sand cutting tests. Table 5-5 describes the effect of feed rate and rotational speed on force and torque measurements.

Table 5-5 Summary of findings for controlled parameters

Controlled parameter	Force	Torque
When increasing feed rate	Increases	Relatively constant
When increasing rotational speed	Increases	Increases

Increasing feed rates led to an increase in force while torque remained relatively constant. Kadirgama et al. (2007) also had similar results. However, they noted that increasing feed rate caused increases in torque as oppose to torque remaining relatively constant. This discrepancy is due to the fact Kadirgama et al. (2007) were milling 618 stainless steel as oppose to oil sand. Increasing rotational speed resulted in both force and torque increasing.

In an attempt to simulate expected field conditions as accurately as possible, tests were performed under various cutting conditions that may be encountered. Also, Tarnng et al. (1995) reported that cutting forces are strongly correlated with cutting conditions. Three cutting conditions were investigated; dry, wet, and frozen. How these cutting conditions influence force and torque values can be summarized in Table 5-6. Cutting oil sand under dry conditions yielded an increase in force while torque remained relatively constant. In wet conditions, tests reveal a decrease in force while torque remained relatively constant. Finally, cutting oil sand under frozen conditions led to increases in force readings with a slight increase in torque.

Table 5-6 Summary of findings for multiple cutting conditions

Cutting condition	Force	Torque
Dry	Increases	Relatively constant
Wet	Decreases	Relatively constant
Frozen	Increases	Slight increase

Analytical modeling of the empirical results were not favourable because of the limited tool speeds. It is suggested that further testing be undertaken with equipment capable at higher tool speeds so that industrial scale-up will be safely achieved.

Energy consumption is reduced with the addition of a fluid during the cutting process. On the contrary, energy consumption was relatively higher when cutting in a frozen environment.

Machinability factor was estimated to be 1.6. This is only applicable for a single-tooth tungsten carbide cutter and serves only as a guide. This should be investigated further, to get estimates of factors for different types of oil sand and cutters, especially for equipment and ores that are more representative of the system concept be undertaken.

5.14 Industrial Scale-up

Experiments were conducted at lab-scale. Industrial scale-up is an important consideration and was investigated to determine the applicability of these results to a full-scale commercial implementation of the system concept. In order for industrial scale-up to be successful, further tests will be required. Specifically, tests with a wider range of conditions (faster feed rates and rotational speeds), different cutter designs, and using more realistic ore types (with interburden). It should be noted Lee et al. (2008) stated that cutting forces in milling operations cannot be scaled-up due to their levels of variation and recommended that actual

physical testing need to be considered. Therefore, it is suggested that these results are only to be used as a guide and that larger-scale testing should be performed.

Chapter 6 Conclusions

6.1 Summary

This work consisted of developing a system concept as a method for accessing, fragmenting, and removing oil sand at intermediate depths. A technical analysis and a cost estimate were also performed. In addition, the applicability of a comparative methodology was demonstrated with case studies.

Oil sand blocks were made for the experiments. These blocks underwent various tests to examine their characteristics. Tests included: extraction testing, shear testing, porosity measurements, and scanning electron microscopy. These tests were conducted according to ASTM standards. Results were within published data.

Lab-scale experiments were conducted in dry, wet, and frozen conditions in support of the fragmentation aspect of the system concept. Thermal imaging was used to qualitatively view temperature variation during the testing process and cutter wear was viewed using a digital microscope both of which are found in the Appendix.

Lab-scale cutting test results obtained are encouraging because of similar findings with Tarng et al. (1995) where they reported that cutting forces are strongly correlated with cutting conditions. However, tests at a larger scale need to be done. Lee et al. (2008) stated that cutting forces in milling operations cannot be scaled-up due to their levels of variation and recommended that actual physical testing need to be considered.

Finally, empirical results were compared against a steady-state cutting model. The theoretical model represented the empirical results quite well showing similar trends within the correct order of magnitude.

6.2 Conclusions

Using a fluid such as water will lower cutting forces and act as a carrier fluid making the fragmented oil sand amiable for slurry transport. However, using a fluid does not appear to have a significant effect on torque readings.

Cutting through frozen oil sand requires a greater amount of force and torque.

The steady-state cutting model did not represent the data well because of the limited feed rates that were possible. Hence, it is recommended that a different cutting model be investigated.

Energy consumption was lower when a fluid was added during the cutting process. Also, cutting frozen oil sand resulted in relatively higher energy consumption.

Machinability factor was estimated to be 1.6 for a 1 in diameter single-tooth tungsten carbide cutter.

The rotational speed of the mill fluctuates. Therefore, it is recommended that the rubber belt in the belt-type variable speed gear box be replaced.

This work studied the feasibility of a novel oil sand production method to access deposits that are currently inaccessible with current technologies. An overall system analysis and lab-scale tests proved to be promising. Therefore, it is advised that this work be continued. However, there are some key uncertainties

that must be addressed in order for the realization of the system concept. These uncertainties fall into two categories; technical and economic. In terms of technical uncertainties, these include but are not limited to: scale-up, cavern support, backfilling, and reliability. With respect to economic uncertainties, a more exhaustive economic assessment must be made since specifications from current technologies will change with new product development.

6.3 Recommendations for Future Work

More tests on the oil sand blocks should be conducted to determine their consistency. Tests may include the use of x-ray diffraction (XRD) to measure mineralogy, x-ray fluorescence (XRF) to measure chemical composition, and/or performing acoustical velocity measurements to determine particle alignment. NMR spectroscopy may be used to verify the results of the Dean-Stark extraction tests.

It was observed that torque measurements were constant with increasing feed rates. However, the tested feed rates were relatively small compared to each other. Further torque measurements need to be made but at a higher and more distinguishable feed rates.

Instead of using water as a carrier fluid for slurry transport, the use of a solvent should be explored. Using a solvent will assist in reducing water consumption and reduce costs associated with water remediation.

A mill that can achieve higher tool speeds should be used in order to validate the results against the steady-state cutting model.

Online tool condition monitoring should be investigated and integrated into the laboratory equipment and is highly recommended for the system concept. This

will allow for maximum cutting while reducing the likelihood of equipment damage.

Cutter wear was qualitatively examined briefly using a digital microscope. Tungsten carbide should be used as opposed to high speed steel. However, a thorough investigation into cutter wear is recommended for reliability issues.

The obtained machinability factor is meant to serve only as a guide. It is paramount that further tests with equipment that is more illustrative of the system concept be undertaken.

More tests at a wider range of testing conditions with different cutter designs, and using more realistic ores should be investigated so that proper industrial scale-up can be achieved.

In order to better represent in-situ conditions, tests should be conducted under pressure.

Tests should be performed on larger samples thereby increasing testing duration. This is so that higher quality data sets can be obtained.

In order to achieve realization of the system concept, other aspects must be investigated. These included but are not limited to: combining the process of water jetting and cutting, developing and testing of a consumable casing, backfilling the excavated cavity, and ground support to prevent borehole roof collapse. Also, a more detailed economic assessment should be performed as technology development is continually advancing.

It should be noted that the results and conclusions are only valid for the conditions tested which was in a lab environment. It must be emphasized that no amount of lab testing can ever replace the importance of field tests since actual field

conditions will ultimately have an influence on the results. Therefore, developing a field pilot is essential.

Finally, learnings from this thesis will add considerable value to future studies and the technical information gained will provide a body of knowledge for subsequent work.

References

- [1] Adams, W.M. (1965). *Nuclear reactor apparatus for earth penetration*. U.S. Patent No. 3,115,194.
- [2] Agar, J.G., Morgenstern, N.R., & Scott, J.D. (1987). Shear strength and stress-strain behaviour of Athabasca oil sand at elevated temperatures and pressures. *Canadian Geotechnical Journal*, 24, 1-10.
- [3] Aguilera, R., Cordell, G.M., Nicholl, G.W., Artindale, J.S., Ng, M.C., & Runions, G.A. (1991). *Horizontal wells: Formation evaluation, drilling, and production, including heavy oil recovery*. Houston, Texas: Gulf Publishing.
- [4] Alberta Chamber of Resources. (2004). *Oil sands technology roadmap: Unlocking the potential*. Edmonton, Alberta.
- [5] Alberta Energy. (2007). *Alberta's Oil Sands 2006*. Edmonton, AB.
- [6] Alberta Energy. (2009). Facts and Statistics. Retrieved October 20, 2009 from <http://www.energy.gov.ab.ca/OilSands/791.asp>
- [7] Anderson, M., Chiovelli, S., & Hoskins, S. (2004). Improving reliability and productivity at Syncrude Canada Ltd. through materials research: past, present, and future. *CIM Bulletin*, 97(1083), 1-5.
- [8] Barr, W.E., Hawes, G.H., Scott, G.R., & Sharpe, J.A. (1992). *Athabasca borehole mining project*. Calgary, Alberta: Imperial Oil Resources Ltd.
- [9] Blouin, S., Hemami, A., & Lipsett, M. (2001). Review of resistive force models for earthmoving processes. *Journal of Aerospace Engineering*, 102-111.
- [10] Bortolotto, S., Lim, G.B., Snider, B.O., & Sury, K.N. (1992). 1991 Cold Lake bore hole mining intermediate pilot, Vol 2: Report on surface processing of oilsands slurry, froth and water. Calgary, Alberta: Esso Resources Canada Ltd.
- [11] Boutelier, D., Schrank, C., & Cruden, A. (2008). Power-law viscous materials for analogue experiments: New data on rheology of highly-filled silicone polymers. *Journal of Structural Geology*, 30:341-353.

- [12] Bradford, A. & Hyman, D. (2004). *Calfrac Well Services Ltd.* Calgary, Alberta: Raymond James Equity Research – Canada.
- [13] Brittin, R.D.A, Pustanyk, B.K., & Sharpe, J.A. (1992). *The performance and evaluation of jetting tools for borehole mining of Cold Lake Oilsands.* Calgary, Alberta: Esso Resources Canada Ltd.
- [14] Butler, R.M. (1994). *Horizontal wells for the recovery of oil, gas and bitumen.* The Petroleum Society of the Canadian Institute of Mining, Metallurgy and Petroleum, Calgary Section.
- [15] Butler, R.M. (1997). *Thermal recovery of oil and bitumen.* Calgary, Alberta: GravDrain Inc.
- [16] Canadian Association of Petroleum Producers. (2004). *Planning horizontal directional drilling for pipeline construction* (CAPP Publication 2004-0022). Calgary, Alberta.
- [17] Devon Energy. (2010). Operations Overview. Available from: <http://www.devonenergy.com/Operations/Pages/operations.aspx#terms?disclaimer=yes> (accessed on Jan 7, 2010).
- [18] Dusseault, M.B. (1978). Shear strength of Athabasca oil sands. *Canadian Geotechnical Journal*, 15, 216-238.
- [19] Dusseault, M.B. (2002). *CHOPS: Cold heavy oil production with sand in the Canadian heavy oil industry.* Waterloo, Ontario: MBDC Inc.
- [20] Eigenbrod, K.D. (1996). Effects of cyclic freezing and thawing on volume changes and permeabilities of soft fine-grained soils. *Canadian Geotechnical Journal*, 33: 529-537.
- [21] Esso Resources Canada Ltd. (1991). *Cold Lake borehole mining project, Phase B pilot: Design basis memorandum.* Calgary, Alberta.
- [22] Esso Resources Canada Ltd. (1992). *Cold Lake borehole mining project: Report to the energy resources conservation board.* Calgary, Alberta.
- [23] Fong, N., Ng, S., Chung, K.H., Tu, Y., Li, Z., Sparks, B.D., & Kotlyar, L.S. (2004). Bitumen recovery from model systems using a warm slurry extraction process: effects of oilsands components and process water chemistry. *Fuel*, 83:1865-1880.

- [24] Fritz, R.D., Horn, M.K., & Joshi, S.D. (1991). *Geological aspects of horizontal drilling*. Tulsa, Oklahoma: The American Association of Petroleum Geologists.
- [25] Gertsch, R.E. & Bullock, R.L. (1998). *Techniques in Underground Mining*. Littleton, Colorado: Society for Mining, Metallurgy, and Exploration, Inc.
- [26] Golosinski, T.S, Wedzicha, J., & Cholewa, W. (1992). Power requirements and resistance to motion of oil sand conveyors during winter operations. *CIM Bulletin*, April 1992.
- [27] Halliburton. (2005). *Conductivity endurance: Keeping it flowing and going: The secret to long-term production*, Houston, Texas: Hart Energy Publishing.
- [28] Hartman, H.L., & Mutmansky, J.M. (2002). *Introductory mining engineering – 2nd ed.* Hoboken, New Jersey: John Wiley & Sons Inc.
- [29] Hedberg, B. (1981). Large-scale underground mining: An alternative to open cast mining. *Mining Magazine*, 148(9):177-183.
- [30] Heidrick, T., & Godin, M. (2006). *Oil sands research and development*. Alberta Energy Oil Sands Development Business Unit. Edmonton, Alberta.
- [31] Hein, F.J., Marsh, R.A. & Boddy, M.J. (2007). Overview of the Oil Sands and Carbonate Bitumen of Alberta. *American Association of Petroleum Geologists Hedberg Conference*. Banff, Alberta.
- [32] Herbich, J.B. (1992). *Handbook of dredging engineering*. New York, New York: McGraw-Hill Inc.
- [33] Hibbeler, J., & Rae, P. (2005). Simplifying hydraulic fracturing – theory and practice. *Society of Petroleum Engineers*, 97311.
- [34] Hilliard, V. (1997). *Drilling – The manual of methods, applications, and management*. Boca Raton, Florida: Lewis Publishers.
- [35] Hong, W. (2001). *Modeling, Estimation, and Control of Robot-Soil Interactions*. (PhD thesis). Massachusetts Institute of Technology, Cambridge, Massachusetts.
- [36] Hupka, J., Milller, J.D., & Drelich, J. (2004). Water-based bitumen recovery from diluent-conditioned oil sands. *The Canadian Journal of Chemical Engineering*, 82:978-985.

- [37] Ibrahim, A.A., & Kagawa, T. (1991). Microscopic measurement of sand fabric from cyclic tests causing liquefaction. *Geotechnical Testing Journal*, 14(4):371-382.
- [38] Imperial Oil Resources Ltd. (1993). *Athabasca Borehole Mining Project*. Calgary, Alberta.
- [39] Imperial Oil Limited. (2010). Imperial Oil – Kearl oil sands project. Available from: http://www.esso.ca/CanadaEnglish/ThisIs/Operations/TI_O_Kearl_Overview.asp (accessed on Jan 7, 2010).
- [40] Ji, H., Robin, E., & Rouxel, T. (2009). Compressive creep and indentation behavior of plasticine between 103 and 353 K. *Mechanics of Materials*, 41:199-209.
- [41] Jimeno, C.L., Jimeno, E.L., & Carcedo, F.J.A. (1995). *Drilling and blasting of rocks*. Brookfield, Virginia: A.A. Balkema Publishers.
- [42] Johnsson, H., Thunholm, B., & Lundin, L. (1995). Experimental system for one-dimensional freezing of undisturbed soil profiles. *Soil Technology*, 7:319-325.
- [43] Joseph, T.G. (2002). OsEIP: The Oil Sands – Equipment Interactions Program. *Canadian Institute of Mining, Metallurgy, and Petroleum*, 95, 1064.
- [44] Joseph, T.G. (2008). *Mining equipment design, benchmarking & performance* [course notes]. School of Mining & Petroleum Engineering, Department of Civil and Environmental Engineering, University of Alberta
- [45] Joshi, S.D. (1991). *Horizontal well technology*. Tulsa, Oklahoma: PennWell Publishing.
- [46] Kalpakjian, S., & Schmid, S.R. (2006). *Manufacturing Engineering and Technology – 5th Ed.* Upper Saddle River, New Jersey: Prentice Hall.
- [47] Kuo, C., & Frost, J.D. (1996). Uniformity evaluation of cohesionless specimens using digital image analysis. *Journal of Geotechnical Testing*, 122(5):390-396.
- [48] Lee, H.U., Cho, D.W., & Ehmann, K.F. (2008). A mechanistic model of cutting forces in micro-end-milling with cutting-condition-independent cutting force coefficients. *Journal of Manufacturing Sciences and Engineering*, 130.

- [49] Li, X.P., & Li, H.Z. (2004). Theoretical modeling of cutting forces in helical end milling with cutter runout. *International Journal of Mechanical Sciences*, 46:1399-1414.
- [50] Li, H.Z., & Li, X.P. (2005). A numerical study of the effects of cutter runout on milling process geometry based on true tooth trajectory. *International Journal of Advanced Manufacturing Technology*, 25:435-443.
- [51] Lipsett, M.G., & Nobes, D.S. (2007). Subterranean fragmentation and dense slurring of oilsand for reducing water use in bitumen production processes. Research proposal to the Imperial Oil – Alberta Ingenuity Centre for Oilsands Innovation.
- [52] Lipsett, M.G., & Speirs, B.C. (2009). Extracting bitumen from subterranean deposits by oilsand fragmentation and slurry transport. Invention disclosure.
- [53] Mader, D. (1989). *Hydraulic proppant fracturing and gravel packing*. Amsterdam, The Netherlands: Elsevier Science Publishers.
- [54] Maurer, W.C. (1968). *Novel drilling techniques*. Fitzroy Square, London: Pergamon Press.
- [55] McClay, K.R. (1976). The rheology of plasticine. *Tectonophysics*, 33:7-15.
- [56] Milfelner, M., Cus, F., & Balic, J. (2005). An overview of data acquisition system for cutting force measuring and optimization in milling. *Journal of Materials Processing Technology*, 164:1281-1288.
- [57] Nilsson, D. (1992). Surface vs. underground methods. Sec. 23.2 in *SME Mining Engineering Handbook – 2nd Ed.* Littleton, Colorado: Society for Mining, Metallurgy, and Exploration.
- [58] Oil Sands Discovery Centre. (2009). *Facts about Alberta's oil sands and its industry*. Fort McMurray, Alberta: Government of Alberta.
- [59] Ola, S.A. (1991). Geotechnical properties and behaviour of Nigerian tar sand. *Engineering Geology*, 30:325-336.
- [60] Robertsen, J. (2008). Oil Sands Production Projects at a Glance. *Oil & Gas Network*, 9(4):19-23.
- [61] Ross, S.L. (1964). *Excavating apparatus and method*. U.S. Patent No. 3,152,651.

- [62] Shaw, M.C. (2005). *Metal cutting principles – 2nd Ed.* New York, New York: Oxford University Press.
- [63] Short, J.A. (1993). *Introduction to directional and horizontal drilling.* Tulsa, Oklahoma: PennWell Publishing.
- [64] Singhai, A.K., Das, S.K., Leggitt, S.M., Kasraie, M., & Ito, Y. (1996). Screening of reservoirs for exploitation by application of steam assisted gravity drainage/vapex processes. *Society of Petroleum Engineers*, 37144.
- [65] Syncrude Canada Ltd. (2010). 2007 Business Results. Available from: <http://sustainability.syncrude.ca/sustainability2007/economic/business/> (accessed on Jan 7, 2010).
- [66] Tarng, Y.S., & Chang, W.S. (1993). Dynamic NC simulation of milling operations. *Computer-Aided Design*, 25(12):769-775
- [67] Tarng, Y.S., Cheng, C.I., & Kao, J.Y. (1995). Modeling of three-dimensional numerically controlled end milling operations. *International Journal of Machine Tools and Manufacturing*, 35(7):939-950.
- [68] Valkó, P. & Economides, M.J. (1995). *Hydraulic fracture mechanics.* West Sussex, England: John Wiley & Sons.
- [69] Viklander, P. (1998). Permeability and volume changes in till due to cyclic freeze/thaw. *Canadian Geotechnical Journal*, 35:471-477.
- [70] Walker, S. (1996). *Comparative underground coal mining methods.* London, United Kingdom: IEA Coal Research.
- [71] Westcott, P. (2004). *Dragline or truck/shovel? Some technical abusiness considerations.* Sydney, Australia: MineConsult Ltd.
- [72] Wheeler, A.J., & Ganji, A.R. (2004). *Introduction to Engineering Experimentation.* Upper Saddle River, New Jersey: Prentice Hall.
- [73] Wong, R.C.K. (1996). Behaviour of water-jet mined caverns in oil sand and shale. *Canadian Geotechnical Journal*, 33:610-617.
- [74] Wong, R.C.K. (1999). Mobilized strength components of Athabasca oil sand in triaxial compression. *Canadian Geotechnical Journal*, 36, 718-735.
- [75] Wong, R.C.K. (2001). Strength of two structured soils in triaxial compression. *International Journal for Numerical and Analytical Methods in Geomechanics*, 25:131-153.

- [76] Wright, T.R. (1991). *World oil's handbook of horizontal drilling and completion technology*. Houston, Texas: Gulf Publishing.
- [77] Zulauf, J., & Zulauf, G. (2004). Rheology of plasticine used as rock analogue: The impact of temperature, composition, and strain. *Journal of Structural Geology*, 26:725-737.

Appendices

A Oil Sand Lump Extraction Procedure

This procedure was developed to give the reader guidance on how to properly extract and transport oil sand lumps for the cutting tests.

Equipment

- A five-passenger vehicle with adequate cargo space and a buggy whip for mine entry.
- A conventional freezer for specimen storage in the lab.
- Air-tight re-sealable pails for specimen transport.
- Markers and labels to identify specimens' lithology.
- Work gloves for handling specimens.
- Plastic sheets and duct tape to wrap and bound specimens.
- Cushioning material to rest pails on which will minimize vibrations during transport.
- Chisel and hammer to break off pieces.
- Circular saw with a diamond blade and hand saw to get specimen to appropriate dimensions.
- Power supply for cutting tools.

Requirements

- Specimens must be kept frozen during transport.
- Specimens must be kept in air-tight re-sealable pails.
- Specimens must be stored in a freezer.

- Care must be taken to minimize disturbance and prevent damage of the specimens.

Procedure

- It is advisable to obtain specimens from a variety of lithologies. This is because some will have relatively higher bitumen content and/or mineral content than the others.
- Locate a block of oil sand and cut the block to required dimensions or if possible obtain a block with the similar dimensions.
- Once the block has been cut, wrap the specimen in plastic and bound the specimen with duct tape.
- Then place the specimen in the air-tight pail. To ensure that there is no space in the pail for the specimen to move around, fill the pail with loose oil sand.
- Place the pails on the foam mattress in the back of the vehicle.
- Once the specimens reach the lab, a plaster of paris will be used to prevent further moisture loss and deterioration.
- The prepared specimens will be returned into the pails and placed into the freezer.

B Energy Consumption Estimation

An important key performance indicator (KPI) used in comparing various mining equipment is energy per unit volume produced. The following is a brief analysis comparing loading shovels, walking draglines, and bucket wheel excavators (BWEs). It is included for informational purposes only.

Introduction

A BWE is a continuous excavator that is effective for mining large amounts of material in weak unconsolidated ground (sand, gravel, etc). BWEs have theoretical outputs of up to 10,000 BCM/hr (Lowrie, 2002).

Power consumption

Power consumption data for BWEs and other surface mining equipment was obtained from Lowrie (2002) and is listed in the following table:

Table 6-1 Power consumptions for various equipment

Equipment	Power consumption (kWh/m ³)
Loading shovel	0.45 - 0.71
Walking dragline	0.88 - 1.21
Bucket wheel excavator	0.30 - 0.50

Table 6-1 lists power consumption ranges in weak unconsolidated ground. They are not specific to oil sands. Information regarding the power consumption of the equipment mentioned in the above table has proven to be extremely difficult to find. Therefore, assumptions will be made in order to approximate the power requirements for operation in an oil sands environment.

The equipment in Table 6-1 operate using electrical power. Conveyors also use electrical power. Therefore, we will assume the power consumption relationship of conveyors will be applicable to shovels, draglines, and BWEs.

Golosinski et al. (1992) studied the power requirements of conveyors operating in oil sands during the winter. They found two factors that had major influence on power requirements; conveying rate and ambient temperature. Only the latter will be applicable to our discussion.

Their results can be summarized by the following two statements:

1. For an *empty* conveyor operating in the winter, each 10°C drop results in an 8% increase in power consumption.
2. For a *loaded* conveyor operating in the winter, each 10°C drop results in a 15% increase in power consumption.

Their second statement is best stated in a tabular form.

Table 6-2 Ambient temperature and its effect on a loaded conveyor’s power consumption

Ambient temperature (°C)	Power consumption increase (%)
0	0
-10	15
-20	30
-30	45
-40	60

In determining the oil sand values for Table 6-3, the upper ranges of the values for weak unconsolidated ground were used as the lower ranges for oil sand. To obtain the upper ranges for oil sand, the following calculation was repeated:

$$0.71 \text{ kWh} / \text{m}^3 \times 1.60 = 1.14 \text{ kWh} / \text{m}^3$$

Table 6-3 Approximate power consumption for surface mining equipment in oil sand

Equipment	Power consumption (kWh/m ³)	
	Weak unconsolidated ground	Oil sand
Loading shovel	0.45 - 0.71	0.71 - 1.14
Walking dragline	0.88 - 1.21	1.21 - 1.94
Bucket wheel excavator	0.30 - 0.50	0.50 - 0.80

Therefore, Table 6-3 lists the approximate and estimated power consumption ranges for oil sand surface mining equipment operating in weak unconsolidated ground and in oil sands.